

HOUSEHOLD LADDER



Basic Stepladder



High Handrail



YQJT-0.9KH



Serrated Step Surface



Anti-skid Rubber Feet

型号 Model - YQJT	0.7KH	0.9KH	1.1KH	1.3KH	1.5KH
阶数 Steps	3	4	5	6	7
扶手高度 Handrail Height (mm)	491	491	491	491	491
平台高度 Platform Height (mm)	655	889	1124	1359	1593
下宽宽度 Bottom Width (mm)	444	479	513	546	582
折叠长度 Folded Length (mm)	1221	1471	1720	1969	2219
折叠厚度 Folded Thickness (mm)	117	117	117	117	117
重量 Weight (kg)	2.5	3	3.5	4.8	5.5
20" (pcs)	537	414	345	276	232
40" (pcs)	1259	971	810	648	544

Aluminium Step Stool



Anti-pinch Joint Lock



YQJT-1.0YB

可选颜色

OPTIONAL COLOR

- 白-White
- 银-Silver
- 黑-Black
- 橙-Orange



Molding Triangular Step



Anti-skid Rubber Feet

型号 Model - YQJT	0.5YB	0.7YB	1.0YB
阶数 Steps	2	3	4
展开高度 A Frame Height (mm)	480	700	955
下宽宽度 Bottom Width (mm)	395	421	453
侧边宽度 Ladder Depth (mm)	412	558	731
折叠长度 Folded Length (mm)	522	752	1024
折叠厚度 Folded Thickness (mm)	164	164	164
重量 Weight (kg)	2	2.9	3.8
20" (pcs)	967	580	403
40" (pcs)	2267	1360	944

Handhold Safety Stepladder



Multi-function Tool Tray



YQJT-0.9V

- 可选颜色**
OPTIONAL COLOR
- 银-Silver
 - 金-Gold
 - 黑-Black

Wide Platform Stepladder



Multi-function Tool Tray



YQJT-4L

- 可选颜色**
OPTIONAL COLOR
- 银-Silver
 - 金-Gold
 - 黑-Black

Slim Wide Stepladder



Mechanical Spreaders



YQJT-0.9H

- 可选颜色**
OPTIONAL COLOR
- 银-Silver
 - 黑-Black

Steel Wide Stepladder

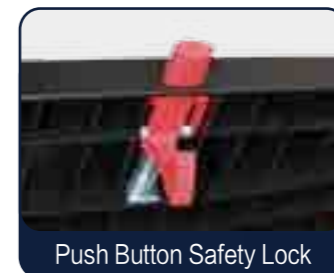

Push Button Safety Lock



SL-40D



29.5x25.5cm Wide Platform



Horseshoe Rubber Feet



35x33cm Wide Platform



Push Button Safety Lock



15cm Wide Anti-skid Step



Anti-skid Rubber Feet

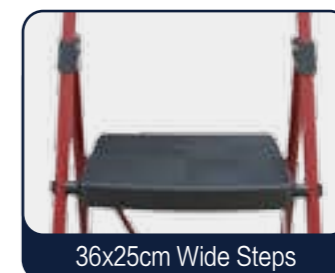

36x25cm Wide Steps

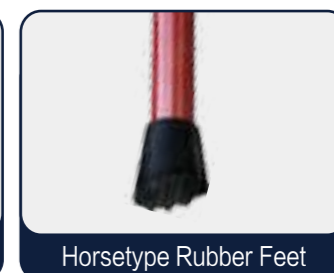

Horseshoe Rubber Feet

型号 Model - YQJT	0.7V	0.9V	1.1V	1.3V	1.5V
阶数 Steps	3	4	5	6	7
扶手高度 Handrail Height (mm)	490	490	490	490	490
平台高度 Platform Height (mm)	671	906	1141	1376	1611
下宽宽度 Bottom Width (mm)	481	512	542	573	604
折叠长度 Folded Length (mm)	1260	1510	1765	2015	2265
折叠厚度 Folded Thickness (mm)	115	115	115	115	115
重量 Weight (kg)	3.7	4.3	5.1	5.8	6.5
20" (pcs)	500	414	337	290	246
40" (pcs)	1173	972	791	680	576

型号 Model - YQJT	3L	4L	5L	6L	7L
阶数 Steps	3	4	5	6	7
扶手高度 Handrail Height (mm)	445	445	445	445	445
平台高度 Platform Height (mm)	714	954	1193	1433	1673
下宽宽度 Bottom Width (mm)	507	532	561	587	614
折叠长度 Folded Length (mm)	1263	1517	1773	2027	2283
折叠厚度 Folded Thickness (mm)	97	97	97	97	97
重量 Weight (kg)	3.3	4	4.7	6.1	6.7
20" (pcs)	456	368	332	232	216
40" (pcs)	1152	864	772	548	528

型号 Model - YQJT	0.7H	0.9H	1.1H
阶数 Steps	3	4	5
扶手高度 Handrail Height (mm)	505	505	505
平台高度 Platform Height (mm)	685	920	1145
下宽宽度 Bottom Width (mm)	430	460	485
折叠长度 Folded Length (mm)	1275	1515	1765
折叠厚度 Folded Thickness (mm)	55	55	55
重量 Weight (kg)	3.6	4.7	5.7
20" (pcs)	806	659	537
40" (pcs)	1889	1545	1259

型号 Model - SL	20D	30D	40D
阶数 Steps	2	3	4
扶手高度 Handrail Height (mm)	540	540	540
平台高度 Platform Height (mm)	480	730	975
下宽宽度 Bottom Width (mm)	475	480	490
折叠长度 Folded Length (mm)	1095	1360	1625
折叠厚度 Folded Thickness (mm)	80	80	80
重量 Weight (kg)	4.3	6.1	7.9
20" (pcs)	645	483	414
40" (pcs)	1511	1133	972

Slim Folding Step



Wide and High Handrail



YQJT-4S

可选颜色

OPTIONAL COLOR

- 银-Silver
- 黑-Black



26x33.5cm Wide Steps



Folding Thickness Only 5cm

Bestep Professional Stepladder



Tool Tray



BST-05G



Anti-skid Steps



Fixed Straps

型号 Model - YQJT	2S	3S	4S
阶数 Steps	2	3	4
扶手高度 Handrail Height (mm)	600	600	600
平台高度 Platform Height (mm)	460	690	925
下宽宽度 Bottom Width (mm)	510	530	560
折叠长度 Folded Length (mm)	1160	1410	1660
折叠厚度 Folded Thickness (mm)	50	50	50
重量 Weight (kg)	4.3	5.4	6.7
20" (pcs)	800	650	530
40" (pcs)	1880	1540	1250

型号 Model - BST	03G	04G	05G	06G	07G
阶数 Steps	3	4	5	6	7
扶手高度 Handrail Height (mm)	640	640	640	640	640
平台高度 Platform Height (mm)	660	885	1115	1335	1540
下宽宽度 Bottom Width (mm)	450	460	490	510	540
折叠长度 Folded Length (mm)	1430	1670	1910	2140	2380
折叠厚度 Folded Thickness (mm)	120	120	120	120	120
重量 Weight (kg)	3.7	4.2	5	6.1	7.1
20" (pcs)	400	341	283	242	207
40" (pcs)	938	800	664	567	486

INDUSTRIAL / HEAVY DUTY LADDER



Platform Stepladder

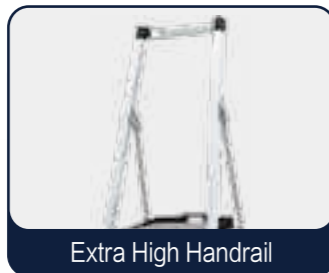

YQZDT-1100



Wide Platform Stepladder



YQFPT-1160A



Wide Platform Stepladder



YQFPT-1160C

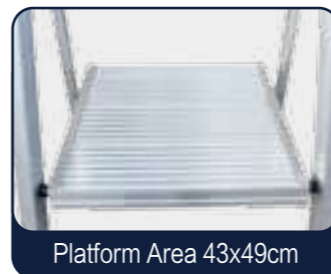

Safety Gate



长度 Length (mm)	612
高度 Height (mm)	54
宽度 Width (mm)	454
重量 Weight (kg)	1.2
20" (pcs)	1450
40" (pcs)	3400



Wheel Kit



长度 Length (mm)	152 / 98
高度 Height (mm)	262 / 242
宽度 Width (mm)	62
重量 Weight (kg)	3.5
20" (sets)	3800
40" (sets)	10600



型号 Model - YQZDT	800	1100	1400	1700	1900
阶数 Steps	3	4	5	6	7
扶手高度 Handrail Height (mm)	905	905	905	905	905
平台高度 Platform Height (mm)	815	1095	1380	1660	1941
下宽宽度 Bottom Width (mm)	620	657	695	733	771
折叠长度 Folded Length (mm)	1879	2179	2478	2778	3078
折叠厚度 Folded Thickness (mm)	170	170	170	170	170
重量 Weight (kg)	8.6	9.7	11.5	13.2	14.8
20" (pcs)	181	153	132	116	100
40" (pcs)	425	358	309	272	235

型号 Model - YQFPT	870A	1160A	1450A	1740A	2030A
阶数 Steps	3	4	5	6	7
扶手高度 Handrail Height (mm)	905	905	905	905	905
平台高度 Platform Height (mm)	870	1160	1450	1740	2030
下宽宽度 Bottom Width (mm)	650	692	735	778	820
折叠长度 Folded Length (mm)	1937	2242	2547	2852	3157
折叠厚度 Folded Thickness (mm)	239	239	239	239	239
重量 Weight (kg)	9.9	11.1	12.3	13.5	14.8
20" (pcs)	112	94	81	71	61
40" (pcs)	262	219	189	166	142

型号 Model - YQFPT	870C	1160C	1450C	1740C	2030C
阶数 Steps	3	4	5	6	7
扶手高度 Handrail Height (mm)	905	905	905	905	905
平台高度 Platform Height (mm)	870	1160	1450	1740	2030
下宽宽度 Bottom Width (mm)	650	692	735	778	820
折叠长度 Folded Length (mm)	1937	2242	2547	2852	3157
折叠厚度 Folded Thickness (mm)	239	239	239	239	239
重量 Weight (kg)	10.6	11.9	13.1	14.3	15.5
20" (pcs)	112	94	81	71	61
40" (pcs)	262	219	189	166	142

Warehouse Ladder



YQCKT-1300



Platform Area 43x43cm

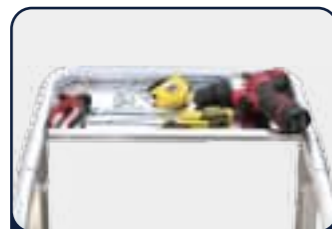

Tool Shelf

Aluminium Folding Platform



SFP-1500



Wide Platform 61x41cm



Step-on Wheel System

型号 Model - YQCKT	1040	1300	1560	1820	2080	2340	2600
阶数 Steps	4	5	6	7	8	9	10
扶手高度 Handrail Height (mm)	910	910	910	910	910	910	910
平台高度 Platform Height (mm)	1040	1300	1560	1820	2080	2340	2600
下宽宽度 Bottom Width (mm)	814	814	1014	1014	1214	1214	1214
折叠长度 Folded Length (mm)	2178	2458	2739	3019	3300	3580	3861
折叠厚度 Fold Thickness (mm)	430	430	430	430	430	430	430
重量 Weight (kg)	17.5	19	21	23.2	25	26.8	28.7
20" (pcs)	153	132	116	108	97	91	83
40" (pcs)	358	309	272	252	227	213	194

Model - SFP	900	1200	1500	1800	2100	2400
阶数 Steps	3	4	5	6	7	8
扶手高度 Handrail Height (mm)	900	900	900	900	900	900
平台高度 Platform Height (mm)	900	1200	1500	1800	2100	2400
Bottom Width (mm)	750	750	750	750	750	750
折叠长度 Folded Length (mm)	2103	2434	2765	3096	3427	3758
折叠厚度 Fold Thickness (mm)	320	320	320	320	320	320
重量 Weight (kg)	21.8	23.3	24.8	26.3	31	32.6
20" (pcs)	60	50	44	40	36	33
40" (pcs)	134	116	103	92	83	76

Adjustable Platform Stepladder



Multi-function Tool Tray



YQSST-1120D



Optional
200mm Adjustable Leg



Optional
Wheel For Easy Movement



Optional
Safety Net



YQSST-1400B



Step-on Wheel System



1/4 Turn Speed Lock

型号 Model - YQSST	840D	1120D	1400D	1680D
阶数 Steps	4x2	4x3	4x4	4x5
扶手高度 Handrail Height (mm)	910	910	910	910
平台高度 Platform Height (mm)	840~1120	1120~1680	1400~2240	1680~2800
下宽宽度 Bottom Width (mm)	650	785	785	785
折叠长度 Folded Length (mm)	1900	2200	2500	2800
折叠厚度 Folded Thickness (mm)	200	200	200	200
重量 Weight (kg)	12.5	15.5	18	20.5
20" (pcs)	138	108	94	83
40" (pcs)	324	252	219	194

型号 Model - YQSST	840B	1120B	1400B	1680B
阶数 Steps	4x2	4x3	4x4	4x5
扶手高度 Handrail Height (mm)	910	910	910	910
平台高度 Platform Height (mm)	840~1120	1120~1680	1400~2240	1680~2800
下宽宽度 Bottom Width (mm)	650	785	785	785
折叠长度 Folded Length (mm)	1900	2200	2500	2800
折叠厚度 Folded Thickness (mm)	260	260	260	260
重量 Weight (kg)	19.2	21.7	24.2	26.7
20" (pcs)	104	81	73	65
40" (pcs)	243	189	170	151

Aluminium Duty Twin Step Ladder



Extra Wide Top Surface

YQSCT-1130



Welded Step



Aluminium Spreader

Heavy Duty Twin Step Ladder



Extra Wide Top Surface

YQSCT-1120



Ladder Feet Brace System



Thick Aluminium

Industrial Double Sided Step Ladder



Stainless Steel Connection

YQAT-3840



Flange Riveted D Rungs



Metal Spreaders

3 Section Combined Ladder



Rung Bracket

YQSJT-8000



Fixed Straps



Bottom Horizontal Stabilizer

型号 Model - YQSCT	850	1130	1410	1690	1970	2250	2540	2820
阶数 Steps	2x3	2x4	2x5	2x6	2x7	2x8	2x9	2x10
展开高度 A Frame Height (mm)	845	1127	1409	1691	1972	2254	2536	2818
下宽宽度 Bottom Width (mm)	470	510	547	584	624	659	699	737
侧边宽度 Ladder Depth (mm)	764	958	1152	1346	1540	1734	1928	2135
折叠长度 Folded Length (mm)	924	1222	1520	1818	2116	2414	2712	3010
折叠厚度 Folded Thickness (mm)	183	183	183	183	183	183	183	183
重量 Weight (kg)	5.1	6.3	7.6	8.9	10.4	12.2	14.1	16
20" (pcs)	414	290	223	171	145	121	102	83
40" (pcs)	972	680	523	400	340	283	231	182

型号 Model - YQSCT	840	1120	1410	1690	1970	2250
阶数 Steps	2x3	2x4	2x5	2x6	2x7	2x8
展开高度 A Frame Height (mm)	843	1127	1409	1690	1972	2254
下宽宽度 Bottom Width (mm)	479	526	573	620	667	714
侧边宽度 Ladder Depth (mm)	764	959	1153	1347	1541	1735
折叠长度 Folded Length (mm)	923	1221	1519	1817	2115	2413
折叠厚度 Folded Thickness (mm)	181	181	181	181	181	181
重量 Weight (kg)	5.5	6.8	8.2	9.7	11.3	13
20" (pcs)	414	290	223	171	145	121
40" (pcs)	972	680	523	400	340	283

型号 Model - YQAT	1860	2520	3180	3840	4500
阶数 Steps	2x5	2x7	2x9	2x11	2x13
A型梯高度 A Frame Height (mm)	1855	2495	3130	3765	4410
下宽宽度 Bottom Width (mm)	1000	1000	1000	1000	1000
侧边宽度 Ladder Depth (mm)	1155	1475	1840	2195	2510
折叠长度 Folded Length (mm)	1935	2585	3250	3910	4570
折叠厚度 Folded Thickness (mm)	230	230	230	230	230
重量 Weight (kg)	14.1	16.8	19.6	22.4	25.2
20" (pcs)	138	104	83	69	59
40" (pcs)	324	243	194	162	139

型号 Model - YQSJT	3820	4660	5500	6340	7180	8000	9700
阶数 Steps	3x7	3x8	3x9	3x10	3x11	3x12	3x14
下宽宽度 Bottom Width (mm)	820	820	820	970	970	970	1060
侧边宽度 Ladder Depth (mm)	1180	1420	1660	1900	2140	2385	2835
折叠长度 Folded Length (mm)	2100	2380	2660	2940	3220	3500	4065
折叠厚度 Folded Thickness (mm)	190	190	190	190	190	190	190
延展长度 Extension Length (mm)	3820	4660	5500	6340	7180	8000	9700
重量 Weight (kg)	14.8	16.5	18.2	19.9	21.6	23.3	26.8
20" (pcs)	153	132	116	108	97	91	78
40" (pcs)	358	309	272	252	227	213	184

Light Duty Two-way Ladder



YQZHT-1.74



Thickened Steel Joints

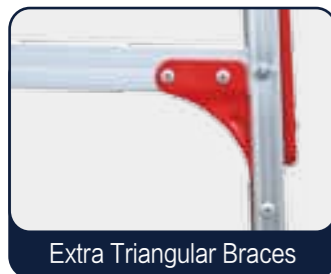

Extra Triangular Braces



Anti-Skid PVC Feet

Aluminium Dual Purpose Ladder



YQZHT-1.67BR



180° Rotating



Welded Step



Ladder Feet Design

Heavy Duty Dual Purpose Ladder



YQZHT-2000



Latch



Welded Step



Functional Steel Lock

Two-joint Aluminium Alloy Ladder



YQGJT-2-3170



Flexible Function Joint



Splayed Stable Structure



Anti-skid Shoes

型号 Model - YQZHT	1.14	1.44	1.74	2.04	2.34
阶数 Steps	2x4	2x5	2x6	2x7	2x8
A型梯高度 A Frame Height (mm)	1110	1405	1695	1985	2285
下宽宽度 Bottom Width (mm)	455	490	525	555	590
折叠长度 Folded Length (mm)	1175	1480	1785	2070	2390
折叠厚度 Folded Thickness (mm)	160	160	160	160	160
直梯长度 Straight Length (mm)	2315	2920	3530	4130	4735
重量 Weight (kg)	5.2	6.2	7.3	9.7	10.9
20" (pcs)	414	290	242	193	171
40" (pcs)	972	680	567	453	400

型号 Model - YQZHT	1.13BR	1.39BR	1.67BR	1.96BR	2.24BR	2.52BR
阶数 Steps	4	5	6	7	8	9
A型梯高度 A Frame Height (mm)	1113	1396	1679	1961	2244	2526
下宽宽度 Bottom Width (mm)	477	514	552	589	627	664
折叠长度 Folded Length (mm)	1199	1497	1795	2093	2391	2688
折叠厚度 Folded Thickness (mm)	155	155	155	155	155	155
直梯长度 Straight Length (mm)	1750	2346	2942	3538	4134	4730
重量 Weight (kg)	4.5	5.5	6.5	7.4	8.7	9.8
20" (pcs)	317	264	213	173	145	121
40" (pcs)	730	608	491	398	287	195

型号 Model - YQZHT	1710	2000	2280
阶数 Steps	6	7	8
A型梯高度 A Frame Height (mm)	1708	1993	2277
下宽宽度 Bottom Width (mm)	561	608	656
折叠长度 Folded Length (mm)	1826	2126	2425
折叠厚度 Folded Thickness (mm)	181	181	181
直梯长度 Straight Length (mm)	3277	3586	4185
重量 Weight (kg)	9.3	10.4	12
20" (pcs)	193	153	132
40" (pcs)	453	358	309

型号 Model - YQGJT	2-3170	2-3765	2-4360	2-4955
阶数 Steps	2x5	2x6	2x7	2x8
A型梯高度 A Frame Height (mm)	1540	1830	2110	2390
下宽宽度 Bottom Width (mm)	610	610	610	610
折叠长度 Folded Length (mm)	1625	1920	2225	2510
折叠厚度 Folded Thickness (mm)	140	140	140	140
直梯长度 Straight Length (mm)	3170	3765	4360	4955
重量 Weight (kg)	7.4	8.5	9.4	10.4
20" (pcs)	223	193	171	145
40" (pcs)	523	453	400	340

Six-joint Multipurpose Ladder



YQGJT-6-3800



型号 Model - YQGJT	6-3800	6-5000
阶数 Steps	4x3	4x4
A型梯高度 A Frame Height (mm)	1830	2395
下宽宽度 Bottom Width (mm)	610	610
折叠长度 Folded Length (mm)	1030	1330
折叠厚度 Folded Thickness (mm)	275	275
直梯长度 Straight Length (mm)	3780	4955
重量 Weight (kg)	12.6	14.3
20" (pcs)	181	138
40" (pcs)	425	324

Two-joint Multipurpose Ladder



YQGNT-4540H



Wide Steps



Wheel (Optional)

型号 Model - YQGNT	3340H	4540H	5740H
阶数 Steps	4x3	4x4	4x5
A型梯高度 A Frame Height (mm)	1605	2170	2755
下宽宽度 Bottom Width (mm)	577	577	655
折叠长度 Folded Length (mm)	1087	1394	1698
折叠厚度 Folded Thickness (mm)	191	191	191
直梯长度 Straight Length (mm)	3340	4540	5740
重量 Weight (kg)	12.1	15.5	18.1
20" (pcs)	242	193	145
40" (pcs)	567	453	340



"U" Lock

Two-joint Multipurpose Ladder



YQGNT-4540F



200mm Adjustable Leg



Thickened Aluminium Joint

型号 Model - YQGNT	3340F	4540F	5740F
阶数 Steps	4x3	4x4	4x5
A型梯高度 A Frame Height (mm)	1605	2170	2755
下宽宽度 Bottom Width (mm)	577	577	655
折叠长度 Folded Length (mm)	1089	1395	1700
折叠厚度 Folded Thickness (mm)	191	191	191
直梯长度 Straight Length (mm)	3340	4540	5740
重量 Weight (kg)	13.6	17	19.5
20" (pcs)	242	193	145
40" (pcs)	567	453	340

Platform & Project Tray



长度 Length (mm)	455
高度 Height (mm)	132
宽度 Width (mm)	317
重量 Weight (kg)	1.6
20" (pcs)	1320
40" (pcs)	3090

Extendable Plank



长度 Length (mm)	1800~2700
高度 Height (mm)	60
宽度 Width (mm)	309
重量 Weight (kg)	10.3
20" (pcs)	880
40" (pcs)	2060

Trestle Brackets



长度 Length (mm)	221
高度 Height (mm)	61
宽度 Width (mm)	125.5
重量 Weight (kg)	0.7
20" (sets)	14500
40" (sets)	34000



Single Ladder



YQDT-3000



Single Ladder



YQDT-4000A



Single Extension Ladder

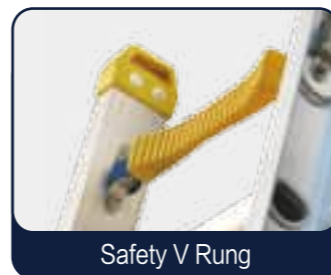

YQDLT-4000

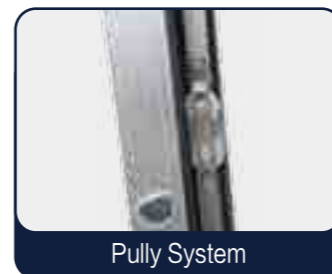
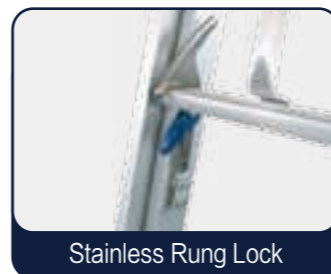

Double Sided Extension Ladder



YQSLT-6520



型号 Model - YQDT	2000	3000	4000	5000	6000
阶数 Steps	6	9	12	15	18
梯子长度 Ladder Length (mm)	2000	3000	4000	5000	6000
下宽宽度 Bottom Width (mm)	455	455	455	455	455
折叠厚度 Folded Thickness (mm)	80	80	80	80	80
重量 Weight (kg)	5.9	8.1	10.2	12.4	14.6
20" (pcs)	483	290	223	171	-
40" (pcs)	1133	680	523	400	340

型号 Model - YQDT	2000A	3000A	4000A	5000A	6000A
阶数 Steps	6	9	12	15	18
梯子长度 Ladder Length (mm)	2000	3000	4000	5000	6000
下宽宽度 Bottom Width (mm)	415	415	415	415	415
折叠厚度 Folded Thickness (mm)	80	80	80	80	80
重量 Weight (kg)	5.4	7.7	9.6	12	14
20" (pcs)	483	290	223	171	-
40" (pcs)	1133	680	523	400	340

型号 Model - YQDLT	4000	5200	6520	7840	9160
阶数 Steps	13	17	21	25	29
扩展长度 Extension Length (mm)	3900	5200	6520	7840	9160
下宽宽度 Bottom Width (mm)	455	455	455	455	455
收合长度 Closed Length (mm)	2710	3370	4035	4690	5355
收合厚度 Closed Thickness (mm)	130	130	130	130	130
重量 Weight (kg)	13.6	16.3	18.2	20.7	23.5
20" (pcs)	171	145	121	104	91
40" (pcs)	400	340	283	243	213

型号 Model - YQSLT	4000	5200	6520	7840
阶数 Steps	2x13	2x17	2x21	2x25
A型梯高度 A Frame Height (mm)	4000	5200	6520	7840
下宽宽度 Bottom Width (mm)	3380	3380	3380	4420
侧边宽度 Ladder Depth (mm)	2430	3060	3755	4420
折叠长度 Folded Length (mm)	2810	3370	4035	4690
折叠厚度 Folded Thickness (mm)	260	260	260	260
重量 Weight (kg)	28.8	34.2	38.6	40.4
20" (pcs)	88	73	61	53
40" (pcs)	206	170	142	124

FIBERGLASS LADDER



Fiberglass Extension Ladder

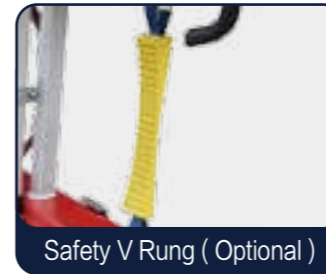

FSDLT-6600B



Fiberglass Extension Ladder

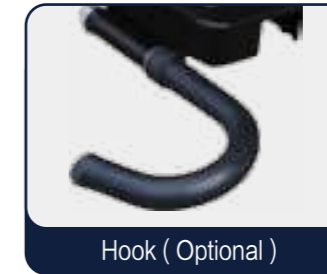

FSDLT-5300C

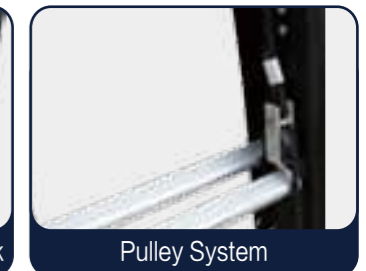

型号 Model - FSDLT	4200B	5400B	6600B	7800B	9000B	10200B
阶数 Steps	16	20	24	28	32	36
延展长度 Extension Length (mm)	4200	5400	6600	7800	9000	10200
下宽宽度 Bottom Width (mm)	445	445	445	445	445	445
折叠长度 Folded Length (mm)	2665	3300	3910	4520	5120	5740
折叠厚度 Folded Thickness (mm)	175	175	175	175	175	175
重量 Weight (kg)	16.4	19.2	22.9	26.6	32.6	34.1
20" (pcs)	138	112	94	83	73	65
40" (pcs)	324	262	219	194	170	151

型号 Model - FSDLT	4100C	5300C	6500C	7700C	8900C	10100C
阶数 Steps	16	20	24	28	32	36
延展长度 Extension Length (mm)	4100	5300	6500	7700	8900	10100
下宽宽度 Bottom Width (mm)	445	445	445	445	445	445
折叠长度 Folded Length (mm)	2565	3200	3810	4420	5020	5640
折叠厚度 Folded Thickness (mm)	175	175	175	175	175	175
重量 Weight (kg)	16.1	18.9	22.6	26.3	32.3	33.8
20" (pcs)	138	112	94	83	73	65
40" (pcs)	324	262	219	194	170	151

Fiberglass Single Side Stepladder



YQFSA-108B



Fiberglass Platform Stepladder



FSZDT-2030

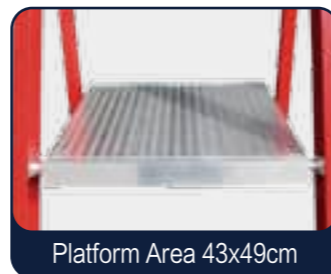
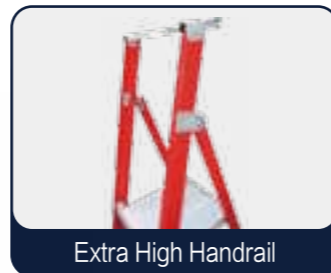

Fiberglass Twin Step Ladder



FSSCT-1130



Fiberglass Dual Ladder



FSZHT-2000

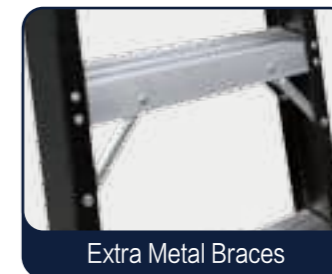

型号 Model - YQFSA	105B	106B	107B	108B	109B	110B	111B	112B
阶数 Steps	4	5	6	7	8	9	10	11
A型梯高度 A Frame Height (mm)	1415	1695	1980	2260	2540	2825	3105	3390
下宽宽度 Bottom Width (mm)	505	540	580	620	655	690	730	765
侧边宽度 Ladder Depth (mm)	995	1180	1360	1540	1725	1905	2085	2265
折叠长度 Folded Length (mm)	1550	1840	2150	2450	2750	3050	3350	3645
折叠厚度 Folded Thickness (mm)	165	165	165	165	165	165	165	165
重量 Weight (kg)	7	8.6	9.8	11.2	12.6	14	15.4	17.2
20" (pcs)	264	223	181	145	126	112	97	88
40" (pcs)	618	523	425	340	296	262	227	206

型号 Model - FSZDT	870	1160	1450	1740	2030
阶数 Steps	3	4	5	6	7
扶手高度 Handrail Height (mm)	908	908	908	908	908
平台高度 Platform Height (mm)	870	1160	1450	1740	2030
下宽宽度 Bottom Width (mm)	649	686	729	771	814
折叠长度 Folded Length (mm)	1937	2242	2544	2853	3156
折叠厚度 Folded Thickness (mm)	239	239	239	239	239
重量 Weight (kg)	12.5	13.8	15.1	16.5	17.8
20" (pcs)	112	94	81	71	61
40" (pcs)	262	219	189	166	142

型号 Model - FSSCT	850	1130	1420	1700	1990	2270	2550	2840
阶数 Steps	2x3	2x4	2x5	2x6	2x7	2x8	2x9	2x10
A型梯高度 A Frame Height (mm)	850	1134	1417	1701	1985	2269	2552	2836
下宽宽度 Bottom Width (mm)	471	508	545	582	619	656	693	730
侧边宽度 Ladder Depth (mm)	767	962	1157	1352	1547	1742	1937	2132
折叠长度 Folded Length (mm)	929	1229	1529	1829	2129	2429	2729	3029
折叠厚度 Folded Thickness (mm)	185	185	185	185	185	185	185	185
重量 Weight (kg)	6.2	7.8	9.4	11	12.6	14.2	15.8	17.4
20" (pcs)	414	290	223	181	153	126	112	97
40" (pcs)	972	680	523	425	358	296	262	227

型号 Model - FSZHT	1710	2000	2280
阶数 Steps	6	7	8
A型梯高度 A Frame Height (mm)	1706	1991	2275
下宽宽度 Bottom Width (mm)	554	609	664
折叠长度 Folded Length (mm)	1820	2120	2420
折叠厚度 Folded Thickness (mm)	180	180	180
直梯长度 Straight Length (mm)	2980	3580	4180
重量 Weight (kg)	9.7	11.5	13.3
20" (pcs)	193	153	126
40" (pcs)	453	358	296

WORK PLATFORM



Mobile Ladder Platform



FPZ5



FP7



可选颜色
OPTIONAL COLOR

- 银-Silver
- 红-Red
- 安全黄
Safety Yellow



Platform Area 60x70cm



Side Stabilizer (FP11-FP14)



Optional
Platform For Bridging



Retractable Wheel System

型号 Model - FP / FPZ	3	4	5	6	7	8	9	10	11	12	13	14
阶数 Steps	3	4	5	6	7	8	9	10	11	12	13	14
扶手高度 Handrail Height (mm)	1000	1000	1000	1000	1000	1000	1000	1000	1000	1000	1000	1000
平台高度 Platform Height (mm)	720	960	1200	1440	1680	1920	2160	2400	2640	2880	3120	3360
侧边宽度 Ladder Depth (mm)	1315	1321	1489	1655	1826	1993	2157	2326	2318	2469	2620	2771
下宽度 Bottom Width (mm)	797	821	862	905	947	989	1032	1075	1115	1157	1199	1241
重量 Weight (kg) - FP / FPZ	28.6/31.1	38.9/41.4	42.3/44.8	46/48.5	51/53.5	54.5/57	58.6/61.1	63.2/65.7	80.6/83.1	86/88.5	92.8/95.3	97.6/100.1
20" (pcs)	74	69	55	48	39	33	29	26	23	19	15	12
40" (pcs)	174	162	128	110	92	78	67	58	50	43	36	30



YQPDT-1500



YQPDT-3000

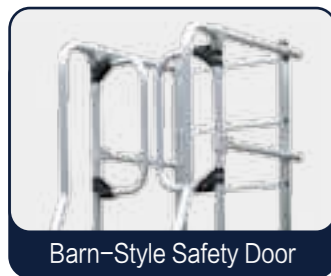

Barn-Style Safety Door

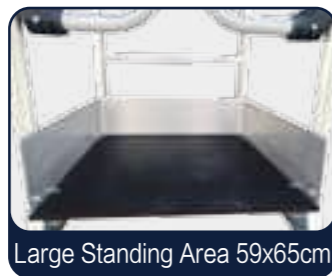

Large Standing Area 59x65cm



Welded Serrated Rungs



Adjustable Support

型号 Model - YQPDT	1000	1500	2000	2500	3000
阶数 Steps	4	6	8	10	12
扶手高度 Handrail Height (mm)	1000	1000	1000	1000	1000
平台高度 Platform Height (mm)	1000	1500	2000	2500	3000
侧边宽度 Ladder Depth (mm)	1181.9	1415.1	1648.2	1881.4	2132.5
下宽宽度 Bottom Width (mm)	1036	1036	1036	1236	2228
重量 Weight (kg)	47	53	62	67.4	92
20" (pcs)	31	26	24	23	22
40" (pcs)	71	64	60	56	52

Platform Load Rating: 150kg

YQPTT-900

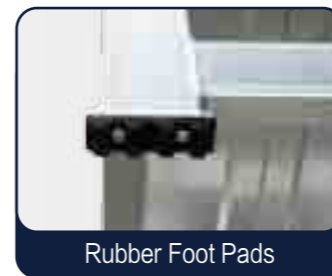
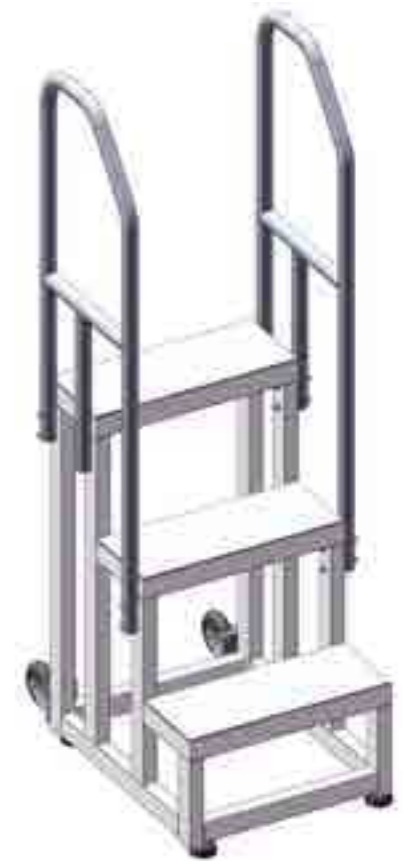

Rubber Foot Pads



Large Step with Non-slip Surface



Optional

Guardrail



Optional

Back Wheels

型号 Model - YQPTT	600	900	1200
阶数 Steps	2	3	4
平台高度 Platform Height (mm)	600	900	1200
侧边宽度 Ladder Depth (mm)	679	979	1279
下宽宽度 Bottom Width (mm)	520	520	520
重量 Weight (kg)	8	10	12
20" (pcs)	207	95	54
40" (pcs)	486	222	128



Paint Platform



型号 Model - YQXC	600A	600B	600C
阶数 Steps	3	3	3
平台宽度 Platform Width (mm)	394	476.5	300
平台高度 Platform Height (mm)	600~700~800	600~700~800	600~700~800
底部宽度 Bottom Width (mm)	476	559	382
平台长度 Platform Length (mm)	1150	1150	1000
重量 Weight (kg)	7.3	8.2	6.5
20" (pcs)	363	290	483
40" (pcs)	850	680	1133

Adjustable Leg Stool



Adjustable heights:
430~590mm



型号 Model - SJFD	590A	590B
平台宽度 Platform Width (mm)	340	450
高度 Height (mm)	430~590	430~590
宽度 Width (mm)	432~496	542~605
长度 Length (mm)	611~743	721~853
重量 Weight (kg)	7	8.5
20" (pcs)	450	400
40" (pcs)	1046	966

Adjustable Height Platform Stool



型号 Model - SJDZT	870x2
高度 Height (mm)	645
宽度 Width (mm)	290
长度 Length (mm)	380
重量 Weight (kg)	8
20" (pcs)	750
40" (pcs)	1790



型号 Model - GDPT	1200	1500	1800	2400	3000
高度 Height (mm)	50	50	50	50	50
宽度 Width (mm)	225	225	225	225	225
长度 Length (mm)	1200	1500	1800	2400	3000
重量 Weight (kg)	4.8	5.9	7	9.3	11.5
20" (pcs)	2271	1886	1581	1210	967
40" (pcs)	5158	4354	3638	2745	2237

Drop Saw Work Bench

6000mm总长度与第二延伸
6000mm Overall Length with 2nd Extension

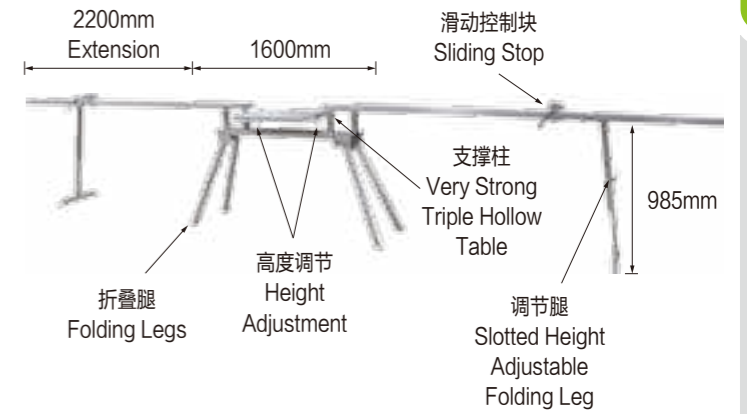

Trestle Safety System



型号 Model	2m	3m	4m	5m	6m
宽度 Width (mm)	225	225	225	225	225
高度 Height (mm)	50	50	50	50	50
重量 Weight (kg)	7.4	11.5	15	19.1	22.5
20" (pcs)	1450	967	580	483	-
40" (pcs)	3400	2237	1360	1133	972



Plank Joiner



Stabilizer Swivel Feet



YQZJ-2400



Trestle Stay



Adjustable Handrail Tube



Handrail Post



Adjustable Legs

型号 Model - YQZJ	1800	2400	3000	3600	4200	4800
阶数 Steps	3	4	5	6	7	8
A型梯高度 A Frame Height (mm)	1900	2479	3058	3637	4216	4795
下宽宽度 Bottom Width (mm)	849	926	1002	1078	1144	1231
侧边宽度 Ladder Depth (mm)	1151	1462	1773	2081	2391	2702
折叠长度 Folded Length (mm)	1913	2513	3113	3708	4307	4907
折叠厚度 Fold Thickness (mm)	179	179	179	179	179	179
重量 Weight (kg)	17.1	22	27.1	32.4	37.9	43.2
20" (pcs)	116	85	64	52	43	36
40" (pcs)	272	200	151	122	102	84

- Trestle ladders
- Planks.
- Telescopic Handrails x 3 are linked to the posts with pivotal graspers that adjust to cope with uneven site conditions.
- Standard length 3 to 5.5m extension. (Custom rails made on request)
- Handrail Post x 2 or more can be used with the full range of trestle heights and mount easily over any two rungs allowing platforms to be used at various heights.
- Trestle Outrigger x 2 or more provide additional stability and heightened security when working at height and can remain attached to the trestle unit when not in use.
- Trestle Stay x 2 or more are close fitting braces that fortifies and prevents the trestle from folding in when in use or when relocating.
- Plank Locks x 2 or more sit underneath connecting planks overcoming trip hazards while maximizing strength for a safe sturdy 450mm working platform.
- Post Ends x 2 or more enclose the workspace providing fall protection at ends.

ALUMINIUM TROLLEY



Foldable Hand Truck



Comfortable Handle

YZTC-390A



Stair Climbing Wheels
(Optional)



Aluminium Plate

Folded Platform Trolley



Painted Handrail

YZTC-600



TPR Low-noise Wheels



Foldable Design

型号 Model - YZTC	390A	390B
扶手高度 Handrail Height (mm)	1000	1000
面板宽度 Panel Width (mm)	390	390
折叠长度 Folded Length (mm)	635	635
折叠厚度 Fold Thickness (mm)	60	95
安全载荷 Load Rating (kg)	68	70
重量 Weight (kg)	3.3	4.2
20" (pcs)	1657	1450
40" (pcs)	3885	3400

型号 Model - YZTC	490	600
扶手高度 Handrail Height (mm)	860	885
平台宽度 Platform Width (mm)	490	600
折叠长度 Folded Length (mm)	780	900
折叠厚度 Fold Thickness (mm)	255	285
安全载荷 Load Rating (kg)	300	400
重量 Weight (kg)	8.7	10.5
20" (pcs)	580	363
40" (pcs)	1360	850

Heavy Duty Hand cart



Double Handrails



Box Section Panel



Castor Wheels

型号 Model - YZTC	650L
展开长度 Exterior Length (mm)	1823
展开宽度 Exterior Width (mm)	652
展开高度 Exterior Height (mm)	1507
安全载荷 Load Rating (kg)	500
重量 Weight (kg)	54.5
20" (pcs)	220
40" (pcs)	485

Aluminium Landing Trolley

YZTC-600P



YZTC-1200P



Castor Wheel



Welded Frame

型号 Model - YZTC	600P	800P	1200P
展开长度 Exterior Length (mm)	600	800	1200
展开宽度 Exterior Width (mm)	600	800	800
展开高度 Exterior Height (mm)	85	85	85
安全载荷 Load Rating (kg)	1200	1200	1200
重量 Weight (kg)	18.1	21.9	24.8
20" (pcs)	572	320	223
40" (pcs)	1340	755	523

Aluminium Frame Trolley



Safety Grip

A Frame Trolley with Ratchet Strap Support Assembly



Ratchet Straps



YZTC-690B



Aluminium Frame



Wheels



Aluminium Frame



Welded Frame

Pan Racks

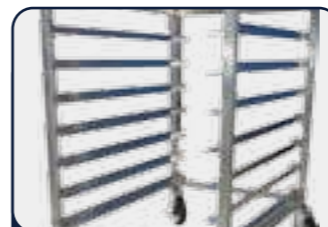

Full Welded Frame



5" PU Wheels

Aluminium Shelf



YZTC-535-5

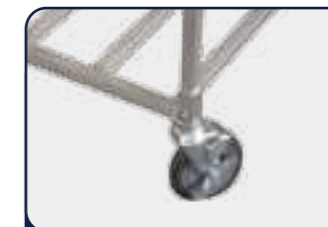

5" PU Wheels



Full Welded Frame

型号 Model - YZTC	690A	690B
展开长度 Exterior Length (mm)	1200	1200
展开宽度 Exterior Width (mm)	690	690
展开高度 Exterior Height (mm)	1200	1200
安全载荷 Load Rating (kg)	500	500
重量 Weight (kg)	36.5	41.6
20" (pcs)	140	140
40" (pcs)	330	330

型号 Model - YZTC	970
展开长度 Exterior Length (mm)	1540
展开宽度 Exterior Width (mm)	970
展开高度 Exterior Height (mm)	1280
安全载荷 Load Rating (kg)	1500
重量 Weight (kg)	61.6
20" (pcs)	76
40" (pcs)	178

型号 Model - YZTC	520
展开长度 Exterior Length (mm)	680
展开宽度 Exterior Width (mm)	521
展开高度 Exterior Height (mm)	775
安全载荷 Load Rating (kg)	100
重量 Weight (kg)	8.8
20" (pcs)	100
40" (pcs)	235

型号 Model - YZTC	535-5	535-8
展开长度 Exterior Length (mm)	688	688
展开宽度 Exterior Width (mm)	535	535
展开高度 Exterior Height (mm)	1453	1704
安全载荷 Load Rating (kg)	100	100
重量 Weight (kg)	13	18.5
20" (pcs)	46	41
40" (pcs)	108	95

Aluminium Rack

YZTC-490-3



Aluminium Cabinet



Full Welded Frame



4" PU Wheels



Full Welded Frame



5" Rubber Wheels

型号 Model - YZTC	490-3	490-4
展开长度 Exterior Length (mm)	660	660
展开宽度 Exterior Width (mm)	490	490
展开高度 Exterior Height (mm)	1610	1610
安全载荷 Load Rating (kg)	100	100
重量 Weight (kg)	12.5	17.1
20" (pcs)	51	51
40" (pcs)	120	120

型号 Model - YZTC	554
展开长度 Exterior Length (mm)	747
展开宽度 Exterior Width (mm)	554
展开高度 Exterior Height (mm)	1802
安全载荷 Load Rating (kg)	100
重量 Weight (kg)	47.5
20" (pcs)	39
40" (pcs)	90

ALUMINIUM SCAFFOLD



梯具 LADDER

铝合金推车 ALUMINIUM TROLLEY

铝合金脚手架 ALUMINIUM SCAFFOLD

定制品 CUSTOM SERIES

Folding Ladder Scaffold

型号 Model	D 0.8m	D 2.2m
展开尺寸 Exterior Size (m)	1.5x0.52x1.5	1.62x0.52x3
平台高度 Platform Height (m)	0.8	2.2
平台尺寸 Platform Size (m)	1.45x0.45	1.45x0.45
重量 Product Weight (kg)	18.2	34.2
40" (pcs)	358	206

Platform Load Rating: 230kg

型号 Model	D 0.8m	D 2.2m
5档框架 5 Rung Frame	2	-
折叠框架 Folded Frame	-	2
开窗踏板 Platform with Hatch	1	1
横拉管 Horizontal Brace	3	4
斜拉管 Diagonal Brace	1	4
支撑脚 Outrigger	-	2
脚轮 Wheel	2	2



Basic Scaffold

型号 Model	B 1.88m
展开尺寸 Exterior Size (m)	1.62x0.73x1.88
平台高度 Platform Height (m)	1.1
平台尺寸 Platform Size (m)	1.62x0.32
重量 Product Weight (kg)	25.8
40" (pcs)	174

Platform Load Rating: 150kg



型号 Model	B 1.88m
折叠框架 Folded Frame	1
横拉管 Horizontal Brace	2
踏板 Platform	2
脚轮 Wheel	4

Extension Ladder Scaffold

型号 Model	T0 3.4m	T0 4.5m	T0 5.6m	T0 6.2m
展开尺寸 Exterior Size (m)	1.8x1.92x4.57	1.8x1.92x5.77	2.21x2.12x6.81	2.21x2.12x7.37
平台高度 Platform Height (m)	1.68~3.36	2.32~4.56	2.8~5.6	3.08~6.16
平台尺寸 Platform Size (m)	1.45x0.6	1.45x0.6	1.88x0.6	1.88x0.6
重量 Product Weight (kg)	109.2	127	146.7	163.9
40" (pcs)	80	59	58	53

Product Standard: EN 1004 Platform Load Rating: 230kg

型号 Model	T0 3.4m	T0 4.5m	T0 5.6m	T0 6.2m
延伸梯 Extension Ladder	2x9	2x12	2x13	2x14
开窗踏板 Platform with Hatch	1	2	2	2
悬臂梁 Outrigger	2	2	2	2
横拉管 Horizontal Brace	8	8	8	8
斜拉管 Diagonal Brace	4	4	4	4
支撑杆 Support Brace	4	4	4	4
底部横梁 Bottom Rail	2	2	2	2
踏板 Platform	-	-	-	1
踢脚板 Toeboard	1	1	1	1
脚轮 Wheel	4	4	4	4



Extension Ladder Scaffold

型号 Model	T 3.3m	T 4.4m	T 5.5m	T 6.1m	T 8.2m
展开尺寸 Exterior Size (m)	1.8x1.92x4.05	1.8x1.92x5.17	2.2x2.1x6.29	2.2x2.1x6.85	2.2x2.6x9.08
平台高度 Platform Height (m)	1.91~3.3	2.47~4.4	3.03~5.5	3.31~6.1	3.13~8.2
平台尺寸 Platform Size (m)	1.45x0.45	1.45x0.45	1.88x0.45	1.88x0.45	1.88x0.56
重量 Product Weight (kg)	81.5	88.4	108	112.4	164
40" (pcs)	87	77	67	63	32

Platform Load Rating: 230kg



型号 Model	T 3.3m	T 4.4m	T 5.5m	T 6.1m	T 8.2m
延伸梯 Extension Ladder	2x8	2x10	2x12	2x13	3x13
开窗踏板 Platform with Hatch	1	1	1	1	1
悬臂梁 Outrigger	2	2	2	2	2
横拉管 Horizontal Brace	8	8	8	8	12
斜拉管 Diagonal Brace	4	4	4	4	6
支撑杆 Support Brace	-	-	4	4	4
底部横梁 Bottom Rail	2	2	2	2	2
脚轮 Wheel	4	4	4	4	4

Economical Scaffold

型号 Model	E 2.0m	E 3.0m	E 4.0m	E 5.0m	E 6.0m
展开尺寸 Exterior Size (m)	1.5x0.7x3.18	1.5x0.7x3.9	1.5x0.7x4.9	1.5x0.7x5.9	1.5x0.7x6.9
平台高度 Platform Height (m)	2	3	4	5	6
平台尺寸 Platform Size (m)	1.5x0.6	1.5x0.6	1.5x0.6	1.5x0.6	1.5x0.6
重量 Product Weight (kg)	42.2	49.9	64.3	76.7	82.5
40" (pcs)	189	166	115	103	92

Product Standard: EN 1004 Platform Load Rating: 230kg

型号 Model	E 2.0m	E 3.0m	E 4.0m	E 5.0m	E 6.0m
8档框架 8 Rung Frame	-	-	-	2	2
7档框架 7 Rung Frame	2	4	4	4	4
4档框架 4 Rung Frame	2	-	2	-	2
开窗踏板 Platform with Hatch	1	1	2	2	2
斜拉管 Diagonal Brace	2	4	6	8	10
横拉管 Horizontal Brace	6	6	6	10	10
悬臂梁 Outrigger	2	2	2	2	2
脚轮 Wheel	4	4	4	4	4



E3.0m

Aluminium Mini Tower

型号 Model	MT 2.0m	MT 4.0m	MT 6.0m
展开尺寸 Exterior Size (m) *	1x0.68x3.3	1x0.68x5.3	1x0.68x7.3
平台高度 Platform Height (m)	2.1	4.1	6.1
平台尺寸 Platform Size (m)	1x0.6	1x0.6	1x0.6
重量 Product Weight (kg)	75	131	168
40" (pcs)	150	84	61

* 展开长度 Exterior Length: 1.5m / 1.2m (Optional)

Product Standard: EN 1004 Platform Load Rating: 230kg

型号 Model	MT 2.0m	MT 4.0m	MT 6.0m
4档框架 4 Rung Frame	6	10	14
踢脚板 Toeboards	1	1	1
开窗踏板 Platform with Hatch	1	2	3
HV拉管 HV Handrail	4	6	8
斜拉管 Diagonal Brace	2	4	6
支撑脚 Stabilizer	-	4	4
脚轮 Wheel	4	4	4

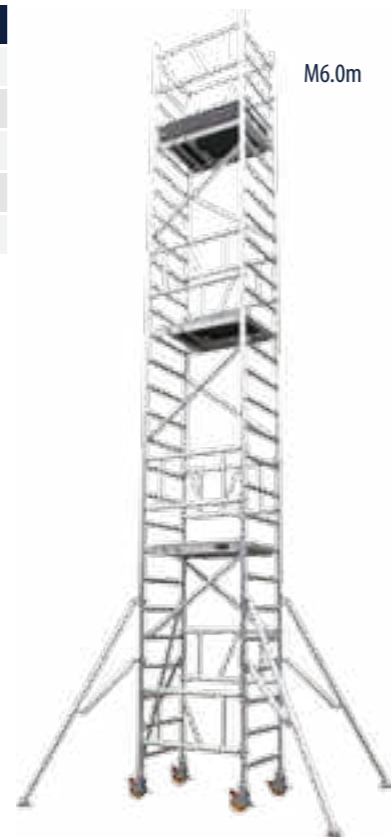

M6.0m



Compact & Easy Transport

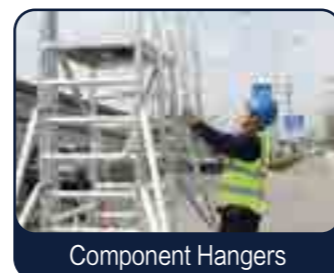

Component Hangers

Mini Snap Scaffold

型号 Model	MS 0.9m	MS 1.8m	MS 3.5m	MS 5.2m
展开尺寸 Exterior Size (m)	2x0.75x1.94	2x0.75x2.86	2x0.75x4.55	2x0.75x6.25
平台高度 Platform Height (m)	0.9	1.8	3.5	5.2
平台尺寸 Platform Size (m)	2x0.6	2x0.6	2x0.6	2x0.6
重量 Product Weight (kg)	47.2	66.7	123	141
40" (pcs)	215	134	67	53

Product Standard: EN 1004 Platform Load Rating: 230kg

型号 Model	MS 0.9m	MS 1.8m	MS 3.5m	MS 5.2m
折叠框架 6 Rung Folded Frame	1	1	1	1
6档框架 6 Rung Frame	-	-	2	4
护栏 2 rung Guard rail	-	2	2	2
开窗踏板 Platform with Hatch	1	1	2	3
斜拉管 Diagonal Brace	-	-	2	4
横拉管 Horizontal Brace	2	5	5	5
铰链 Hinge	1	1	1	1
支撑脚 Stabilizer	-	-	4	4
踢脚板 Toeboard	-	1	1	1
脚轮 Wheel	4	4	4	4



MS 1.8m

Folded Scaffold - V Type

型号 Model	V 0.9m	V 1.8m	V 3.5m	V 5.2m
展开尺寸 Exterior Size (m)	1.4x0.68x1.94	1.4x0.68x2.84	1.4x0.68x4.52	1.4x0.68x6.26
平台高度 Platform Height (m)	0.9	1.8	3.5	5.2
平台尺寸 Platform Size (m)	1.4x0.6	1.4x0.6	1.4x0.6	1.4x0.6
重量 Product Weight (kg)	34.2	45.5	111.2	134.2
40" (pcs)	219	136	71	57

Product Standard: EN 1004 Platform Load Rating: 230kg

型号 Model	V 0.9m	V 1.8m	V 3.5m	V 5.2m
折叠框架 Folding Frame	1	1	1	1
6档框架 6 Rung Frame	-	-	2	4
护栏 Guard Rail	-	2	2	2
开窗踏板 Platform with Hatch	1	1	2	3
H型护栏 Handrail	-	2	2	2
斜拉管 Diagonal Brace	-	-	2	4
踢脚板 Toeboard	-	-	1	1
支撑脚 Stabilizer	-	-	4	4
脚轮 Wheel	4	4	4	4



V3.5m

Folded Scaffold - H Type

型号 Model	H 0.9m	H 1.8m	H 3.5m	H 5.2m
展开尺寸 Exterior Size (m)	1.8x0.68x1.94	1.8x0.68x2.84	1.8x0.68x4.52	1.8x0.68x6.26
平台高度 Platform Height (m)	0.9	1.8	3.5	5.2
平台尺寸 Platform Size (m)	1.8x0.6	1.8x0.6	1.8x0.6	1.8x0.6
重量 Product Weight (kg)	42	53	119.4	149.4
40" (pcs)	162	105	58	47

Product Standard: EN 1004 Platform Load Rating: 230kg

型号 Model	H 0.9m	H 1.8m	H 3.5m	H 5.2m
折叠框架 Folding Frame	1	1	1	1
6档框架 6 Rung Frame	-	-	2	4
护栏 Guard Rail	-	2	2	2
开窗踏板 Platform with Hatch	1	1	2	3
H型护栏 Handrail	-	2	2	2
斜拉管 Diagonal Brace	-	-	2	4
踢脚板 Toeboard	-	-	1	1
支撑脚 Stabilizer	-	-	4	4
脚轮 Wheel	4	4	4	4



Folded Scaffold - HF Type

型号 Model	HF 0.9m	HF 1.8m	HF 3.5m	HF 5.2m
展开尺寸 Exterior Size (m)	1.8x0.68x1.94	1.8x0.68x2.84	1.8x0.68x4.52	1.8x0.68x6.26
平台高度 Platform Height (m)	0.9	1.8	3.5	5.2
平台尺寸 Platform Size (m)	1.8x0.6	1.8x0.6	1.8x0.6	1.8x0.6
重量 Product Weight (kg)	41.8	52	117.4	145.4
40" (pcs)	161	104	57	46

Product Standard: EN 1004 Platform Load Rating: 230kg

型号 Model	HF 0.9m	HF 1.8m	HF 3.5m	HF 5.2m
折叠框架 Folding Frame	1	1	1	1
6档框架 6 Rung Frame	-	-	2	4
护栏 Guard Rail	-	2	2	2
开窗踏板 Platform with Hatch	1	1	2	3
H型护栏 Handrail	-	2	2	2
斜拉管 Diagonal Brace	-	-	2	4
踢脚板 Toeboard	-	-	1	1
支撑脚 Stabilizer	-	-	4	4
脚轮 Wheel	4	4	4	4



Single Width Scaffold

型号 Model	SW 2.0m	SW 3.3m	SW 5.0m	SW 6.2m
展开尺寸 Exterior Size (m)	1.915x0.68x3.04	1.915x0.68x4.27	1.915x0.68x5.91	1.915x0.68x7.14
平台高度 Platform Height (m)	2	3.3	5	6.2
平台尺寸 Platform Size (m)	1.915x0.6	1.915x0.6	1.915x0.6	1.915x0.6
重量 Product Weight (kg)	80.8	121.3	149.5	182.5
40" (pcs)	128	79	60	49

Product Standard: EN 1004 Platform Load Rating: 230kg

型号 Model	SW 2.0m	SW 3.3m	SW 5.0m	SW 6.2m
5档框架 5 Rung Frame	2	2	2	6
4档框架 4 Rung Frame	-	-	2	-
3档框架 3 Rung Frame	-	2	2	-
护栏 Guard Rail	2	2	2	2
开窗踏板 Platform with Hatch	1	1	2	3
H型护栏 Handrail	2	2	2	2
斜拉管 Diagonal Brace	2	6	8	12
横拉管 Horizontal Brace	2	2	2	2
对角拉管 Bottom Brace	1	1	1	1
踢脚板 Toeboard	1	1	1	1
支撑脚 Stabilizer	-	4	4	4
脚轮 Wheel	4	4	4	4



Single Width Scaffold with Vertical Ladder

型号 Model	SWI 4.2m	SWI 6.2m	SWI 8.2m	SWI 10.2m
展开尺寸 Exterior Size (m)	2x0.75x5.28	2x0.75x7.28	2x0.75x9.28	2x0.75x11.28
平台高度 Platform Height (m)	4.2	6.2	8.2	10.2
平台尺寸 Platform Size (m)	2x0.6	2x0.6	2x0.6	2x0.6
重量 Product Weight (kg)	140.9	178.2	244.7	282
40" (pcs)	81	58	42	35

Product Standard: EN 1004 Platform Load Rating: 230kg

型号 Model	SWI 4.2m	SWI 6.2m	SWI 8.2m	SWI 10.2m
5档内梯框架 5 Rung Ladder Frame	2	3	4	5
5档框架 5 Rung Frame	2	3	4	5
护栏 Guard Rail	2	2	2	2
开窗踏板 Platform with Hatch	1	2	4	5
对角拉管 Bottom Brace	1	1	1	1
斜拉管 Diagonal Brace	6	8	12	14
横拉管 Horizontal Brace	6	6	10	10
踢脚板 Toeboard	1	1	1	1
支撑脚 Stabilizer	4	4	4	4
脚轮 Wheel	4	4	4	4

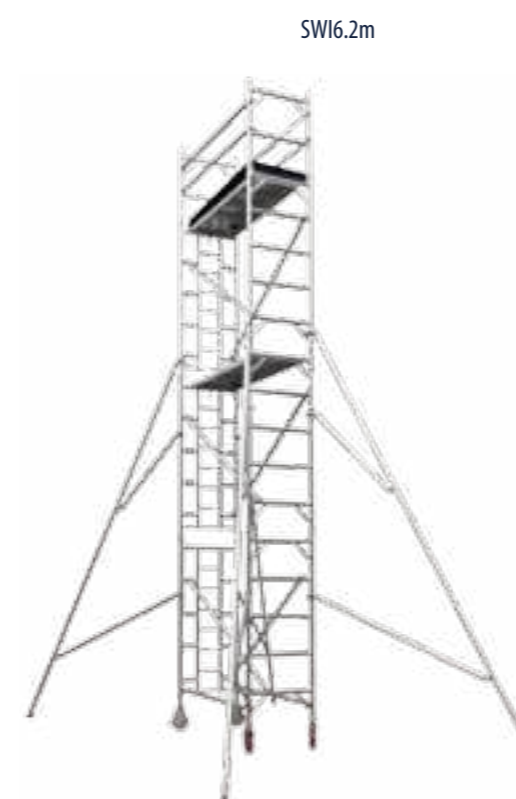

Single Width Scaffold with Inclined Ladder

型号 Model	SWS 2.2m	SWS 3.0m	SWS 3.8m	SWS 4.2m	SWS 5.0m	SWS 6.3m
展开尺寸 Exterior Size (m)	2.5x0.68x3.23	2.5x0.68x4.03	2.5x0.68x4.83	2.5x0.68x5.23	2.5x0.68x6.03	2.5x0.68x7.23
平台高度 Platform Height (m)	2.2	3	3.8	4.2	5	6.3
平台尺寸 Platform Size (m)	2.5x0.6	2.5x0.6	2.5x0.6	2.5x0.6	2.5x0.6	2.5x0.6
重量 Product Weight (kg)	116	158	170	172.2	183.8	195
40" (pcs)	114	66	63	62	60	56

Product Standard: EN 1004 Platform Load Rating: 230kg

型号 Model	SWS 2.2m	SWS 3.0m	SWS 3.8m	SWS 4.2m	SWS 5.0m	SWS 6.3m
5档框架 5 Rung Frame	2	-	2	4	2	6
4档框架 4 Rung Frame	-	2	2	-	2	-
3档框架 3 Rung Frame	-	2	-	-	2	-
6m挂梯 6m Extension Ladder	-	-	1	1	1	-
4m挂梯 4m Extension Ladder	-	1	-	-	-	2
护栏 Guard Rail	2	2	2	2	2	2
开窗踏板 Platform with Hatch	1	1	1	1	1	2
3m挂梯 3m Single Ladder	1	-	-	-	-	-
斜拉管 Diagonal Brace	4	6	8	8	10	12
横拉管 Horizontal Brace	6	6	6	6	6	6
对角接管 Bottom Brace	1	1	1	1	1	1
踢脚板 Toeboard	1	1	1	1	1	1
支撑脚 Stabilizer	-	4	4	4	4	4
挂梯支撑架 Ladder Support	1	1	1	1	1	2
脚轮 Wheel	4	4	4	4	4	4



Double Width Scaffold with Inclined Ladder

型号 Model	DWS 2.2m	DWS 3.0m	DWS 3.8m	DWS 4.2m	DWS 5.0m	DWS 6.3m
展开尺寸 Exterior Size (m)	2.5x1.25x3.23	2.5x1.25x4.03	2.5x1.25x4.83	2.5x1.25x5.23	2.5x1.25x6.03	2.5x1.25x7.23
平台高度 Platform Height (m)	2.2	3	3.8	4.2	5	6.3
平台尺寸 Platform Size (m)	2.5x0.54	2.5x0.54	2.5x0.54	2.5x0.54	2.5x0.54	2.5x0.54
重量 Product Weight (kg)	146	191	209	212.4	226.4	255
40" (pcs)	72	52	50	49	46	41

Product Standard: EN 1004 Platform Load Rating: 230kg

型号 Model	DWS 2.2m	DWS 3.0m	DWS 3.8m	DWS 4.2m	DWS 5.0m	DWS 6.3m
5档框架 5 Rung Frame	2	-	2	4	2	6
4档框架 4 Rung Frame	-	2	2	-	2	-
3档框架 3 Rung Frame	-	2	-	-	2	-
4m挂梯 4m Extension Ladder	-	1	-	-	-	2
6m挂梯 6m Extension Ladder	-	-	1	1	1	-
护栏 Guard Rail	2	2	2	2	2	2
开窗踏板 Platform with Hatch	1	1	1	1	1	2
踏板 Platform	1	1	1	1	1	2
3m挂梯 3m Single Ladder	1	-	-	-	-	-
斜拉管 Diagonal Brace	4	6	8	8	10	12
横拉管 Horizontal Brace	6	6	6	6	6	6
对角接管 Bottom Brace	1	1	1	1	1	1
踢脚板 Toeboard	1	1	1	1	1	1
支撑脚 Stabilizer	/	4	4	4	4	4
挂梯支撑架 Ladder Support	1	1	1	1	1	2
脚轮 Wheel	4	4	4	4	4	4



Double Width Scaffold with Vertical Ladder

型号 Model	DWI 4.0m	DWI 4.8m	DWI 6.0m	DWI 8.0m	DWI 10.0m
展开尺寸 Exterior Size (m)	2.5x1.25x5.29	2.5x1.25x6.29	2.5x1.25x7.29	2.5x1.25x9.29	2.5x1.25x11.29
平台高度 Platform Height (m)	4	4.8	6	8	10
平台尺寸 Platform Size (m)	2.5x0.54	2.5x0.54	2.5x0.54	2.5x0.54	2.5x0.54
重量 Product Weight (kg)	177.6	227.9	249.6	316.5	347
40" (pcs)	43	33	30	23	20

Product Standard: EN 1004 Platform Load Rating: 230kg

型号 Model	DWI 4.0m	DWI 4.8m	DWI 6.0m	DWI 8.0m	DWI 10.0m
5档框架 5 Rung Frame	2	-	3	4	5
5档内梯框架 5 Rung Ladder Frame	2	-	3	4	5
4档框架 4 Rung Frame	-	3	-	-	-
4档内梯框架 4 Rung Ladder Frame	-	3	-	-	-
护栏 Guard Rail	2	2	2	2	2
开窗踏板 Platform with Hatch	1	2	2	3	3
踏板 Platform	1	2	2	3	3
H护栏 Handrail	2	2	2	2	2
斜拉管 Diagonal Brace	8	10	14	18	22
横拉管 Horizontal Brace	2	2	2	2	2
对角接管 Bottom Brace	1	1	1	1	1
踢脚板 Toeboard	1	1	1	1	1
支撑脚 Stabilizer	4	4	4	4	4
脚轮 Wheel	4	4	4	4	4

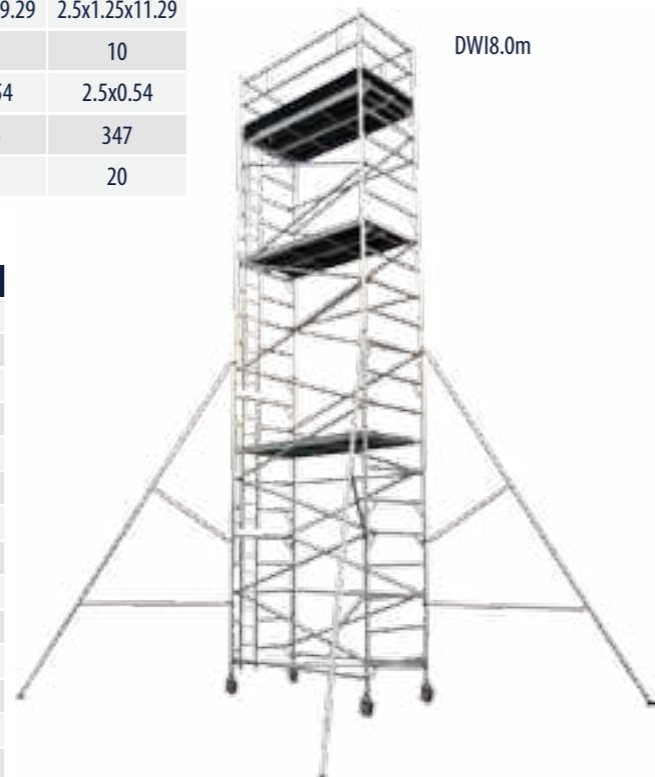

Double Width Scaffold with Stair Case

型号 Model	DWC 4.4m	DWC 6.3m	DWC 8.3m	DWC 10.3m	DWC 12.3m
展开尺寸 Exterior Size (m)	2.5x1.45x5.6	2.5x1.45x7.56	2.5x1.45x9.52	2.5x1.45x11.48	2.5x1.45x13.44
平台高度 Platform Height (m)	4.4	6.3	8.3	10.3	12.3
平台尺寸 Platform Size (m)	2.5x0.6	2.5x0.6	2.5x0.6	2.5x0.6	2.5x0.6
重量 Product Weight (kg)	298.7	386.4	474	561.7	649.3
40" (pcs)	15	11	8	7	6

Product Standard: EN 1004 Platform Load Rating: 230kg

型号 Model	DWC 4.4m	DWC 6.3m	DWC 8.3m	DWC 10.3m	DWC 12.3m
7档框架 7 Rung Frame	4	6	8	10	12
4档框架 4 Rung Frame	2	2	2	2	2
1档框架 1 Rung Frame	2	2	2	2	2
踏板 Platform	2	3	4	5	6
Z型走梯 Stairway	2	3	4	5	6
走梯扶手 Stair Handrail	2	3	4	5	6
平台侧护栏 Advance Guardrail	2	3	4	5	6
顶部平台护栏 Top platform guardrail set	1	1	1	1	1
斜拉管 Diagonal Brace	2	2	2	2	2
横拉管 Horizontal Brace	2	2	2	2	2
对角接管 Bottom Brace	1	1	1	1	1
踢脚板组件 Toeboard set	1	1	1	1	1
支撑脚 Stabilizer	4	4	4	4	4
脚轮 Wheel	4	4	4	4	4

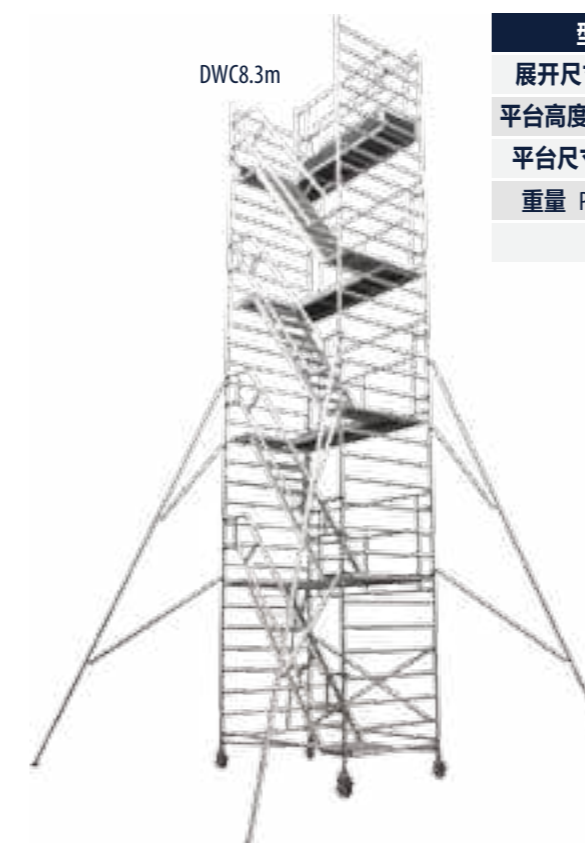



Aluminum kwikstage is a universally established prefabricated scaffolding system. Used for both access and shoring applications, its inherent simplicity is what makes kwikstage become a more versatile, efficient and cost effective alternative to traditional tube and coupler scaffolds.

Product Standard: EN 1004, AS/NZS 1576 Platform Load Rating: 230kg



Base Jack

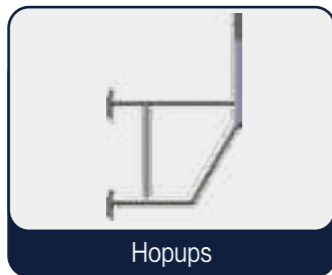

Hopups



Modular Construction



Single Ladder



Ledger

型号 Model	KS 506	KS 680	KS 1280	KS 2000	KS 2500	KS 3200
管直径 Tube Diameter (mm)	48.4	48.4	48.4	48.4	48.4	48.4
管壁厚 Tube Thickness (mm)	2.6	2.6	2.6	2.6	2.6	2.6
长度 Length (mm)	506	680	1280	2000	2500	3200
重量 Product Weight (kg)	1.1	1.3	1.9	2.6	3.2	3.9



Standard

型号 Model	KS 0.5	KS 1.0	KS 1.5	KS 2.0	KS 2.5	KS 3.0
管直径 Tube Diameter (mm)	48.4	48.4	48.4	48.4	48.4	48.4
管壁厚 Tube Thickness (mm)	2.6	2.6	2.6	2.6	2.6	2.6
长度 Length (mm)	500	1000	1500	2000	2500	3000
重量 Product Weight (kg)	2.6	3.2	3.8	4.4	5	6.1



Diagonal Brace

型号 Model	KS 1583	KS 1647	KS 1972	KS 3202	KS 3534
管直径 Tube Diameter (mm)	44.4	44.4	44.4	44.4	44.4
管壁厚 Tube Thickness (mm)	3.4	3.4	3.4	3.4	3.4
长度 Length (mm)	1583	1647	1972	3202	3534
重量 Product Weight (kg)	1.8	1.9	2.3	3.6	3.9



Platform

型号 Model	KS-A(P)	KS-B(P)	KS-C(P)	KS-D(P)
宽度 Width (mm)	600	600	600	600
长度 Length (mm)	1364	2084	2584	3284
重量 Product Weight (kg)	13	18	21	27



Platform with Hatch

型号 Model	KS-A(PH)	KS-B(PH)	KS-C(PH)	KS-D(PH)
宽度 Width (mm)	600	600	600	600
长度 Length (mm)	1364	2084	2584	3284
重量 Product Weight (kg)	11	16	19	25



Multidirectional aluminum ringlock scaffolding is all-round multi-directional aluminum alloy scaffold. It is engineered to employ single aluminum tubes without height restriction and much more flexible than portal frame scaffold, applied to any height, any venue, and any complex engineering condition.

Product Standard: EN 1004, AS/NZS 1576 Platform Load Rating: 230kg



Base Jack



Platform with Hatch



Modular Construction



Stairway



Ledger

型号 Model	BS 732	BS 1092	BS 1332	BS 1400	BS 2072	BS 2572
管直径 Tube Diameter (mm)	48.4	48.4	48.4	48.4	48.4	48.4
管壁厚 Tube Thickness (mm)	3.2	3.2	3.2	3.2	3.2	2.6
长度 Length (mm)	732	1092	1332	1400	2072	2572
重量 Product Weight (kg)	1.4	1.9	2.4	2.7	3.1	3.6



Standard

型号 Model	BS 1.0	BS 2.0	BS 3.0	BS 4.0
管直径 Tube Diameter (mm)	48.4	48.4	48.4	48.4
管壁厚 Tube Thickness (mm)	3.2	3.2	3.0	3.2
长度 Length (mm)	1000	2000	3000	4000
重量 Product Weight (kg)	1.9	3.1	4.4	5.8



Diagonal Brace

型号 Model	BS 732x2000	BS 1332x2000	BS 1572x2000	BS 2572x2000
管直径 Tube Diameter (mm)	48.3	48.3	48.3	48.3
管壁厚 Tube Thickness (mm)	2	2	2	2
长度 Length (mm)	732	1332	1572	2572
重量 Product Weight (kg)	2.4	2.7	2.8	3.3



Platform

型号 Model	BS-A(P)	BS-B(P)	BS-C(P)	BS-D(P)
宽度 Width (mm)	600	600	600	600
长度 Length (mm)	1400	1572	2072	2572
重量 Product Weight (kg)	15	16	19	22



Platform with Hatch

型号 Model	BS-A(PH)	BS-B(PH)	BS-C(PH)	BS-D(PH)
宽度 Width (mm)	600	600	600	600
长度 Length (mm)	1400	1572	2072	2572
重量 Product Weight (kg)	14	15	18	21

ALUMINIUM 'Z' STAIRS

- Much safer to use than ladders, carry tools and equipment easily
- Lightweight – easy one man handling
- Fast – dramatically increase scaffolding efficiency
- Stairs can be manufactured to fit ALL scaffold systems



型号 Model	Z 2.0m	Z 2.5m	Z 3.0m
高度 Height (mm)	1800	2000	3000
长度 Length (mm)	2000	2500	3000
宽度 Length (mm)	540	640	640
重量 Product Weight (kg)	18.9	21.9	25.9
安全载荷 Load Rating (kg)	230	230	230

STILLAGES

Aluminium Stillages are designed for store scaffold system components, reducing 'shrinkage' onsite with easy visual stocktake

Aluminium vs. Steel Aluminium lasts longer, is lighter weight and quicker to erect looks better over time, will not corrode, and is cheaper to transport



型号 Model	S-400
高度 Height (mm)	1040
长度 Length (mm)	1385
宽度 Length (mm)	1385
重量 Product Weight (kg)	11.5
安全载荷 Load Rating (kg)	400

Aluminium Truss Beams

The Aluminium Beam has been designed utilising many decades of aluminium engineering expertise

Robust and lightweight aluminium construction and fully-welded joints



Lightweight aluminium construction - less than half the weight of steel
 All joints fully-welded using the latest CMT technology
 All node gaps are large enough to connect a standard scaffold fitting
 Designed in accordance with all relevant standards

型号 Model	A 4.0m	A 6.0m	A 8.0m
高度 Height (mm)	400	400	400
长度 Length (mm)	4000	6000	8000
宽度 Length (mm)	48.4	48.4	48.4
重量 Product Weight (kg)	15.7	22.9	30.5
安全载荷 Load Rating (kg)	150	150	150

INDUSTRIAL LADDERS & PLATFORMS



Rolling Step Ladder

Platform Load Rating: 150kg

YQPTT-1000



Mobile Work Platform

Platform Load Rating: 150kg

YQDCP-4360D



型号 Model - YQPTT	500	750	1000
阶数 Steps	2	3	4
展开长度 Exterior Length (mm)	899	1043	1187
展开宽度 Exterior Width (mm)	731	774	818
平台高度 Platform Height (mm)	500	750	1000
平台尺寸 Platform Size (mm)	650x530	650x530	650x530
护栏高度 Guardrail Height (mm)	1000	1000	1000
重量 Product Weight (kg)	23	25.9	29.6

型号 Model - YQDCP	2100A	3000B	3800C	4360D
阶数 Steps	9	15	14	19
展开长度 Exterior Length (mm)	2575	2742	3119	3942
展开宽度 Exterior Width (mm)	1350	700	2000	1800
平台高度 Platform Height (mm)	2100	3000	3800	4360
平台尺寸 Platform Size (mm)	1200x800	700x600	1100x800	700x600
护栏高度 Guardrail Height (mm)	1000	1011	1000	1150
重量 Product Weight (kg)	148	105	117	170

Cantilever Platform

Platform Load Rating: 200kg



CP-3080

Crossover Platform

Platform Load Rating: 200kg



PL1200

ST1000

Pit Ladders

Load Rating: 150kg



PITDT-3200



Aluminium Hook Ladder

Load Rating: 150kg



FMDT-012



Checker Plate



Gate with Auto-lock



Boom Arm



Feet Base with Holes



Modular Design



Mounting Brackets



Hooks



Fully Welded

型号 Model - CP	1680	1960	2240	2520	2800	3080
阶数 Steps	6	7	8	9	10	11
展开长度 Exterior Length (mm)	2639	2755	2871	2987	3103	3219
展开宽度 Exterior Width (mm)	900	900	900	900	900	900
平台高度 Platform Height (mm)	1680	1960	2240	2520	2800	3080
护栏高度 Guardrail Height (mm)	904	904	904	904	904	904
平台尺寸 Platform Size (m)	2x0.9	2x0.9	2x0.9	2x0.9	2x0.9	2x0.9
重量 Product Weight (kg)	156	169	175	184	208	221

型号 Model - PL	900	1200	1500	1800
护栏高度 Product Weight (mm)	900	900	900	900
平台长度 Platform Length (mm)	900	1200	1500	1800
平台宽度 Platform Width (mm)	700	700	700	700
重量 Product Weight (kg)	40	45	51	60

型号 Model - ST	750	1000	1250	1500
阶数 Steps	2	3	4	5
展开长度 Exterior Length (mm)	802	1078	1343	1620
展开宽度 Exterior Width (mm)	760	760	760	760
重量 Product Weight (kg)	18	22	29	33

型号 Model - PITDT	2600	3200
阶数 Steps	9	11
长度 Length (mm)	2600	3200
宽度 Width (mm)	362	362
直杆宽度 Stile Width (mm)	50	50
重量 Product Weight (kg)	7.2	7.9

型号 Model - FMDT	006	008	012	015	016
阶数 Steps	6	8	12	15	16
长度 Length (mm)	1800	2178	3178	3928	4178
宽度 Width (mm)	375	375	375	375	375
直杆宽度 Stile Width (mm)	70	70	70	70	70
重量 Product Weight (kg)	4.5	5.7	8.2	10	10.6

Mezzanine Ladder

Load Rating: 200kg



GLFT-5100

Self-levelling Stair

Load Rating: 450kg



SLS1200x18

Aluminium Cage Ladder

Load Rating: 150kg



Adjustable Scaffolding Access Ladder

Platform Load Rating: 150kg

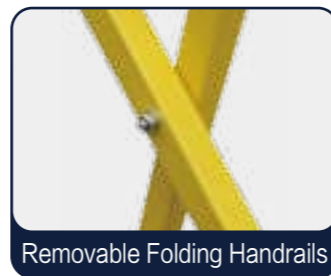

型号 Model - GLFT	2100	3100	3700	4100	5100	6500
阶数 Steps	8	11	13	15	18	23
展开长度 Exterior Length (mm)	2100	3100	3700	4100	5063	6444
展开宽度 Exterior Width (mm)	650	650	650	650	650	650
侧边宽度 Side Width (mm)	1107	1532	1787	1956	2321	2910
扶手高度 Handrail Height (mm)	1000	1000	1000	1000	1000	1000
重量 Product Weight (kg)	26	38	43	46.7	56	70

型号 Model - SLS	650x6	650x9	650x12	650x15	650x18
阶数 Steps	6	9	12	15	18
高度范围 Height range (mm)	600~1350	1290~2000	1800~2700	2600~3375	3300~4000
扶手高度 Handrail Height (mm)	1000	1000	1000	1000	1000
展开宽度 Exterior Width (mm)	650	650	650	650	650
重量 Product Weight (kg)	60.1	85.4	107.1	130.5	155.7

型号 Model - SLS	1200x6	1200x9	1200x12	1200x15	1200x18
阶数 Steps	6	9	12	15	18
高度范围 Height range (mm)	600~1350	1290~2000	1800~2700	2600~3375	3300~4000
扶手高度 Handrail Height (mm)	1000	1000	1000	1000	1000
展开宽度 Exterior Width (mm)	1200	1200	1200	1200	1200
重量 Product Weight (kg)	77.4	110.5	140.8	170.2	204.4

型号 Model - WLDT	3690
阶数 Steps	10
展开长度 Exterior Length (mm)	3690
展开宽度 Exterior Width (mm)	416
围栏直径 Cage Diameter (mm)	800
围栏高度 Cage Height (mm)	2050
重量 Product Weight (kg)	22

型号 Model - SSFT	1475
阶数 Steps	5
展开长度 Exterior Length (mm)	2224
展开宽度 Exterior Width (mm)	558
平台高度 Platform Height (mm)	988~1475
护栏高度 Guardrail Height (mm)	749
重量 Product Weight (kg)	20.5

Aluminium Ramps

Platform Load Rating: 150kg

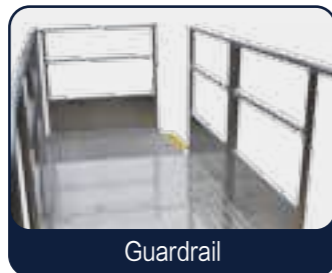

型号 Model - PDDT	4400
展开长度 Exterior Length (mm)	4400
展开宽度 Exterior Width (mm)	1200
展开高度 Exterior Height (mm)	1332
护栏高度 Guardrail Height (mm)	1100
重量 Product Weight (kg)	198

Custom Aluminium Stair

Platform Load Rating: 200kg



STAIR-3030

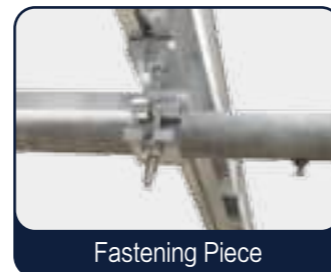
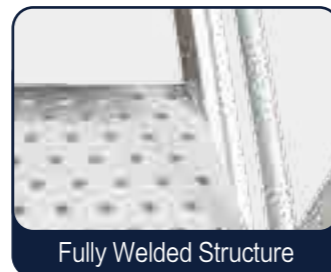

型号 Model - STAIR	4200	3030	3222
阶数 Steps	6	7	8
展开长度 Exterior Length (mm)	4200	3034	3222
展开宽度 Exterior Width (mm)	1500	800	1264
踏步长度 Step Length (mm)	800	740	1110
踏步深度 Step Depth (mm)	350	179	276.4
重量 Product Weight (kg)	94	55	85

TRAINS & RAIL TRANSPORT LADDERS, PLATFORMS



Railway Trolley

Platform Load Rating: 300kg



Panel Fence



Wheels

Railway Trolley

Platform Load Rating: 600kg



Handrails with Brake



Hollow Platform

型号 Model - GDTC	01
展开长度 Exterior Length (mm)	800
展开宽度 Exterior Width (mm)	620
平台高度 Platform Height (mm)	860
面板尺寸 Panel Size (mm)	800x620
重量 Product Weight (kg)	15

型号 Model - GDTC	03
展开长度 Exterior Length (mm)	1650
展开宽度 Exterior Width (mm)	780
平台高度 Platform Height (mm)	850
面板尺寸 Panel Size (mm)	1650x780
重量 Product Weight (kg)	26.5

Train Working Platform

Platform Load Rating: 200kg



Catenary Repair Scaffolding

Platform Load Rating: 230kg



Track Clamp



Strong Lifting Hook



型号 Model - CRS	7240
展开尺寸 Exterior Size (m)	1.8x2x7.24
平台高度 Platform Height (m)	3.7~6.3
护栏高度 Guardrail Height (m)	1.1
重量 Product Weight (kg)	278.4

Railway Scaffolding

型号 Model	DWR 6.0m	DRW 10.0m	DWR 12.0m
展开尺寸 Exterior Size (m)	1.8x1.45x7.29	1.8x1.45x11.29	1.8x1.45x13.29
工作高度 Platform Height (m)	6	10	12
平台尺寸 Platform Size (m)	1.8x0.6	1.8x0.6	1.8x0.6
重量 Product Weight (kg)	279.6	377	436

Platform Load Rating: 230kg

型号 Model	DWR 6.0m	DWR 10.0m	DWR 12.0m
5档框架 5 Rung Frame	3	5	6
5档内梯框架 5 Rung Ladder Frame	3	5	6
护栏 Guard Rail	2	2	2
开窗踏板 Platform with Hatch	2	3	5
踏板 Platform	2	3	5
H型护栏 Handrail	2	2	2
斜拉管 Diagonal Brace	14	22	26
横拉管 Horizontal Brace	12	20	24
对角拉管 Bottom Brace	1	1	1
踢脚板 Toeboard	1	1	1
底座 Bottom Base Unit	1	1	1
支撑脚 Stabilizer	4	4	4

DWR 6.0m



Railway Repair Scaffolding

型号 Model	GDJXC4000	GDJXC6000	GDJXC8000
展开尺寸 Exterior Size (m)	4.31x1.57x4.82	5.16x2.73x7.4	4.37x2.73x9.23
工作高度 Platform Height (m)	4	6	8
侧平台高度 Side Platform Height (m)	3~3.3~3.5	5.13~5.38~5.63~5.88	3.68~3.93~4.18
重量 Product Weight (kg)	248	409.2	390.8

Platform Load Rating: 250kg

型号 Model	GDJXC4000	GDJXC6000	GDJXC8000
6档框架 6 Rung Frame	2	/	/
6档底座框架 6 Rung Pedestal Frame	2	/	/
主平台 Main Platform	1	1	1
侧平台 Side Platform	2	2	2
斜拉管 Diagonal Brace	4	10	14
横拉管 Horizontal Brace	4	10	13
底座 Bottom Base Unit	1	1	1
踏板 Platform	2	2	2
拉绳组件 Rope Set	/	4	4
4档框架 4 Rung Frame	/	6	8
2档护栏 Guard	/	2	2
H型护栏 Top Handrail	/	2	2
辅助支撑 Auxiliary Support Frame	/	4	4

GDJXC8000



Railway Scaffolding

型号 Model	JSJGDD-3.7m
展开尺寸 Exterior Size (m)	1.8x1.45x4.88
工作高度 Platform Height (m)	3.7
平台尺寸 Platform Size (m)	1.8x0.6
重量 Product Weight (kg)	175

Platform Load Rating: 230kg

型号 Model	JSJGDD-3.7m
2档框架 2 Rung Frame	2
3档框架 3 Rung Frame	1
3档内梯框架 3 Rung Ladder Frame	1
4档框架 4 Rung Frame	1
4档内梯框架 4 Rung Ladder Frame	1
开窗踏板 Platform with Hatch	1
踏板 Platform	2
横拉管 Horizontal Brace	8
底座 Bottom Base Unit	1



Wheel Locking



Platform Locking

Railway Sound Barrier Repair Scaffolding

型号 Model	JSJSG-6.2m
展开尺寸 Exterior Size (m)	8.08x1.45x6.87
工作高度 Platform Height (m)	6.2
平台尺寸 Platform Size (m)	1.8x0.6
重量 Product Weight (kg)	605

Product Standard: EN 1004 Platform Load Rating: 230kg

型号 Model	JSJSG-6.2m
4档框架 4 Rung Frame	2
4档内梯框架 4 Rung Ladder Frame	2
3档内梯框架 3 Rung Ladder Frame	6
3档框架 3 Rung Frame	6
踏板 Platform	2
开窗踏板 Platform with Hatch	2
横拉管 Horizontal Brace	4
斜拉管 Diagonal Brace	24
三角架 Hopups	8
轨道横拉杆 Railway Horizontal Brace	6
小踏板 Small Platform	8
底座 Bottom Base Unit	2



Stair Climbing Working Ladder

Platform Load Rating: 150kg



型号 Model	RJ-5200
平台高度 Platform Height (m)	2.7~4.2
平台尺寸 Platform Size (m)	0.6x0.8
重量 Product Weight (kg)	75

型号 Model	RJ-5200
2m拉伸梯 2m Extension Ladder	1
3m拉伸梯 3m Extension Ladder	1
工作平台 Work Platform	1
工具箱 Tool Box	1
斜拉管 Diagonal Brace	2
横拉管 Horizontal Brace	2
侧边斜撑 Side Outriggers	4
星形螺栓 Star Bolts	8

Truck Access Platforms

Platform Load Rating: 450kg



型号 Model	2m-C	3m-C	4m-C	5.8m-C
护栏高度 Guardrail Height (mm)	1000	1000	1000	1000
展开长度 Exterior Length (mm)	3195	4195	5195	6995
平台高度 Platform Height (mm)	1400	1400	1400	1400
平台尺寸 Platform Size (mm)	2000x750	3000x750	4000x750	5800x750
重量 Product Weight (kg)	171.5	206	226.1	278

Scissor-Type Hydraulic Lifting Platform

Platform Load Rating: 300kg



型号 Model - YQSJP	3400
护栏高度 Guardrail Height (mm)	900
展开宽度 Exterior Width (mm)	2360
平台高度 Platform Height (mm)	1150~3400
重量 Product Weight (kg)	1700

Tanker Truck ladder

Platform Load Rating: 150kg



型号 Model - YQSJP	4500
护栏高度 Guardrail Height (mm)	1250
展开宽度 Exterior Width (mm)	1220
平台高度 Platform Height (mm)	3000~4500
平台尺寸 Platform Size (mm)	1300x1300
重量 Product Weight (kg)	461

AVIATION PLATFORMS, MAINTENANCE PLATFORMS



Boarding Platform

Platform Load Rating: 150kg

YQDTT-4000

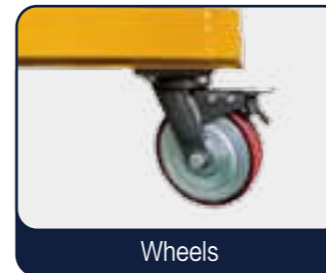

型号 Model - YQDTT	4000	4000A
平台尺寸 Size (mm)	2400X1500	1000x1200
展开长度 Exterior Length (mm)	4854	4554
护栏高度 Guardrail Height (mm)	1050	1050
平台高度 Platform Height (mm)	2600~3900	2600~3900

Working Ladder

Platform Load Rating: 150kg



型号 Model - YQDTT	2.4m
阶数 Steps	8
展开长度 Exterior Length (mm)	2661
护栏高度 Guardrail Height (mm)	850
平台高度 Platform Height (mm)	2400

Working Ladder

Platform Load Rating: 150kg



Working Ladder

Platform Load Rating: 150kg



Working Ladder

Platform Load Rating: 150kg



Step Stand

Platform Load Rating: 200kg



型号 Model - YQDTT	1.95m
阶数 Steps	9
展开长度 Exterior Length (mm)	2100
护栏高度 Guardrail Height (mm)	750
平台高度 Platform Height (mm)	1950

型号 Model - YQDTT	1.5m
阶数 Steps	7
展开长度 Exterior Length (mm)	1800
展开宽度 Exterior Width (mm)	900
平台高度 Platform Height (mm)	1500

型号 Model - YQDTT	1.25m
阶数 Steps	6
展开长度 Exterior Length (mm)	1285
护栏高度 Guardrail Height (mm)	700
平台高度 Platform Height (mm)	1250

型号 Model - YQDTT	0.7m	0.92m
阶数 Steps	3	4
展开长度 Exterior Length (mm)	840	1120
展开宽度 Exterior Width (mm)	480	480
平台高度 Platform Height (mm)	700	920

Boarding Step

Platform Load Rating: 200kg

YDTT-1500

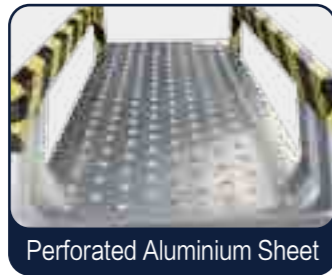

型号 Model - YQDCP	1000A	1500
阶数 Steps	4	6
展开长度 Exterior Length (mm)	1947	2450
展开宽度 Exterior Width (mm)	600	600
平台高度 Platform Height (mm)	1000	1500
重量 Product Weight (kg)	45	130

Adjustable Boarding Ladder

Platform Load Rating: 150kg

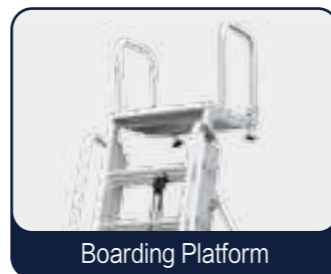

型号 Model - BL	4530
阶数 Steps	16
展开长度 Exterior Length (mm)	1845
展开宽度 Exterior Width (mm)	1120
平台高度 Platform Height (mm)	4530
护栏高度 Guardrail Height (mm)	450
重量 Product Weight (kg)	106



PLANT LADDERS, PLATFORMS & STAIRS

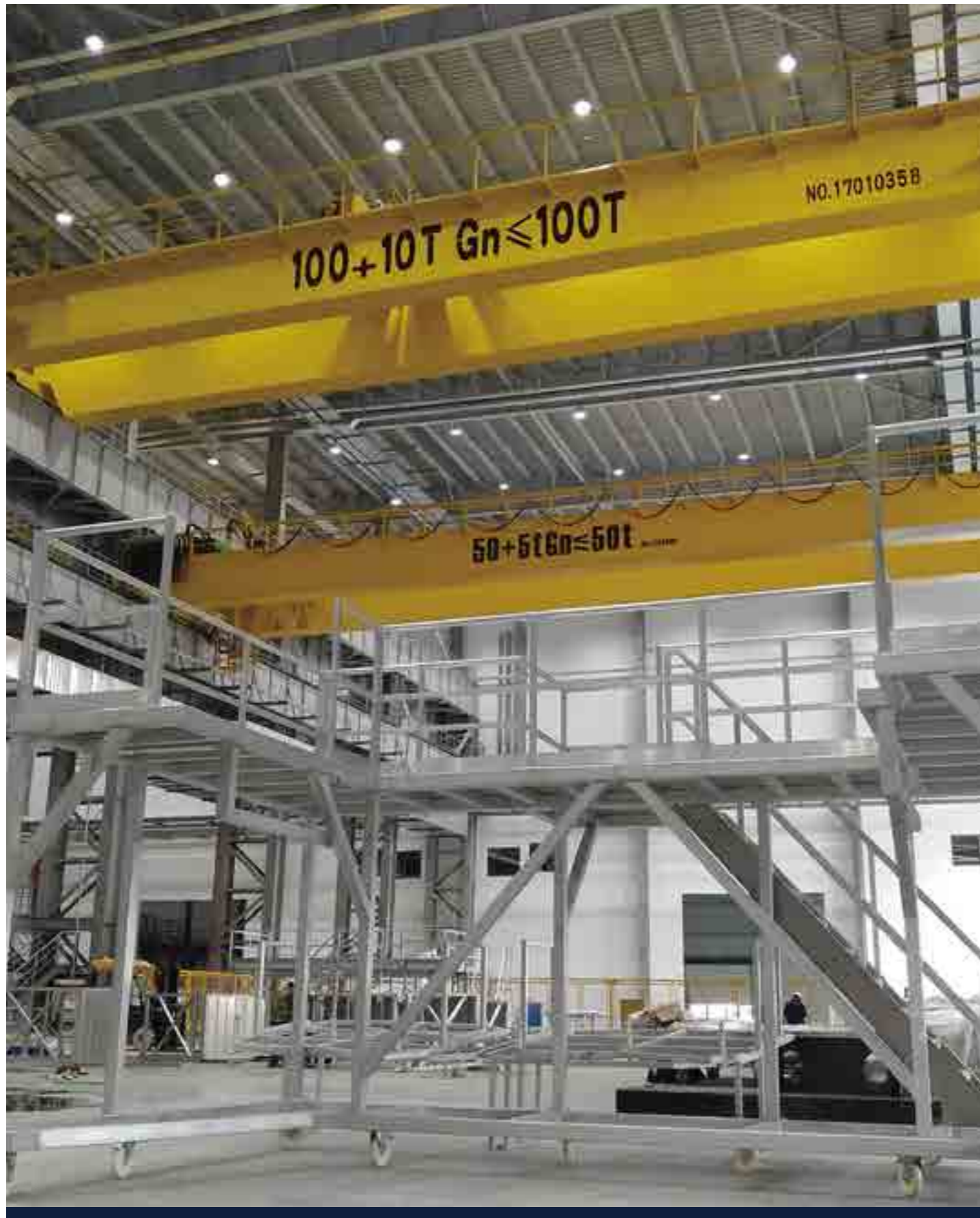

Podium Step

Platform Load Rating: 150kg



型号 Model - YZHT	1200
阶数 Steps	3
展开长度 Exterior Length (mm)	1250
展开宽度 Exterior Width (mm)	700
平台高度 Platform Height (mm)	1200
护栏高度 Guardrail Height (mm)	1000
重量 Product Weight (kg)	46

Access Solutions for Factory Equipment

3D演示图

平面尺寸图

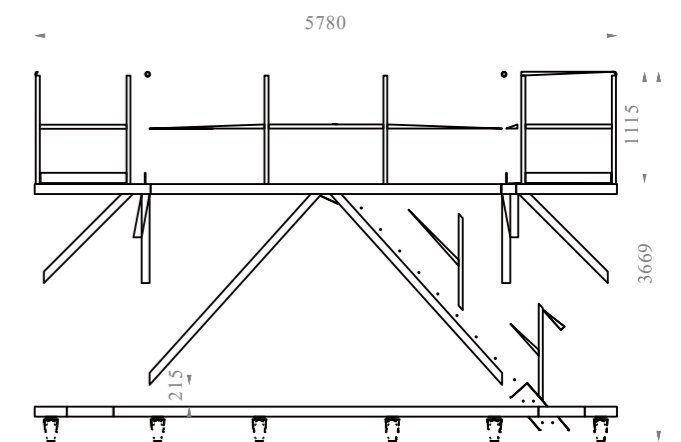
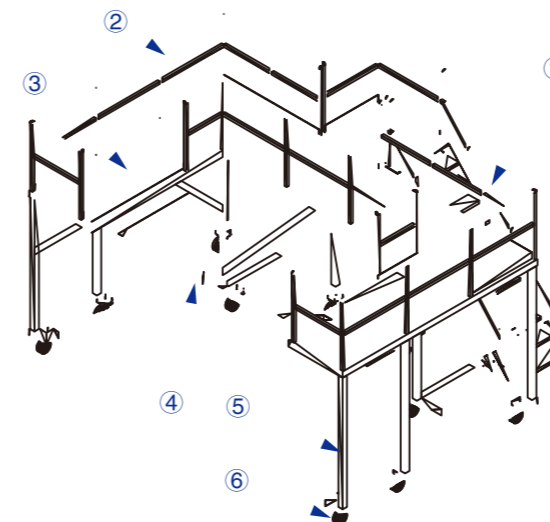

- 1) 走梯组件: 最大安全载荷400kg, 适用2人(含工具)
Ladder assembly: maximum safety load 400kg, suitable for 2 persons
- 2) 护栏组件: 护栏的高度1115mm
Guardrail set: guardrail height 1115mm
- 3) 平台组件: 最大安全载荷1500kg, 适用4人(含工具)
Platform set: maximum safety load 1500kg, suitable for 4 persons

- 4) 底框架组件: 边长100mm厚度5mm的方型铝合金材质
Bottom frame assembly: aluminum box section 100*100*5mm
- 5) 平台立柱组件: 边长80mm厚度5mm的方型铝合金材质
Frame post set: aluminum box section 80*80*5mm
- 6) 带刹脚轮: 最大动态安全载荷800kg, 高度200mm
Brake casters: maximum dynamic safety load 800kg with diameter 200mm

Access Solutions for Factory Equipment

3D演示图

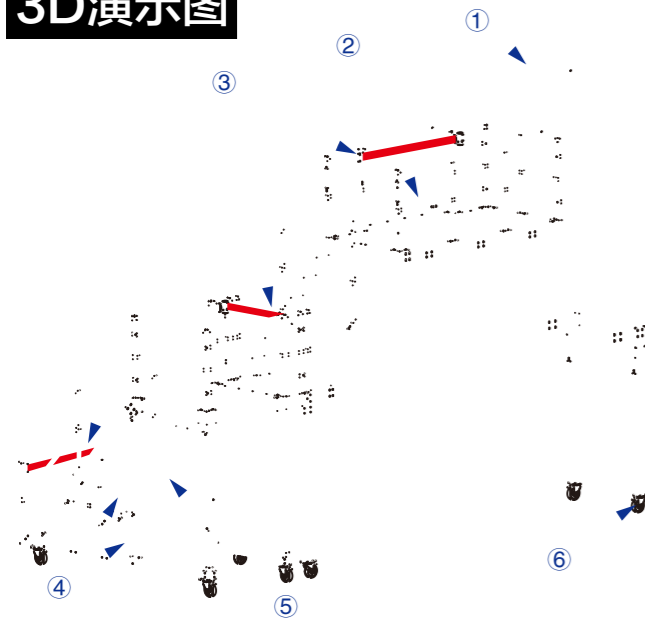

- 1) 工具箱: 最大安全载荷15kg
Toolbox: maximum safety load 15kg
- 2) 进入机舱口: 可进出同样高度的机舱处作业
Access to engine room: work in and out of engine room at the same height
- 3) 警示带: 警示带有缠绕装置
Warning belt: Warning belt with winding device

平面尺寸图

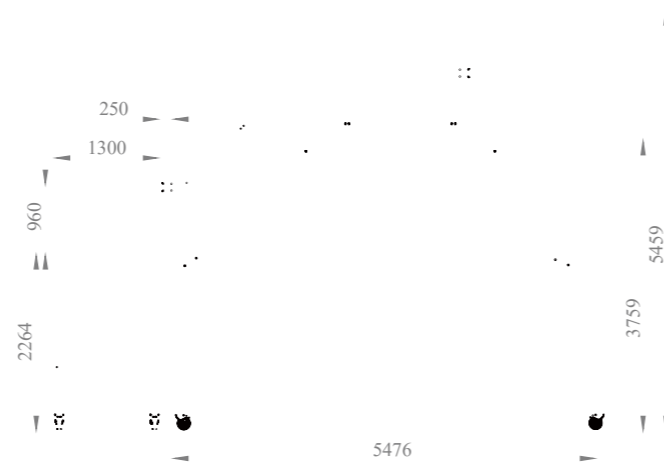

- 4) 货架: 最大安全载荷30kg
Shelf: maximum safety load 30kg
- 5) 指示板: 可书写相关信息的塑料白板
Dashboard: Plastic whiteboard on which relevant information can be written
- 6) 带刹脚轮: 最大动态安全载荷800kg, 高度200mm
Brake casters: maximum dynamic safety load 800kg with diameter 200mm



Access Solutions for Factory Equipment

3D演示图

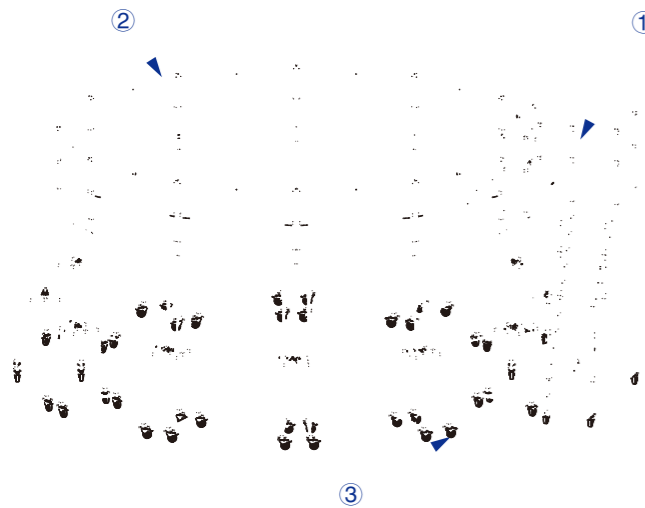

- 1) 走梯组件: 最大安全载荷166kg, 适用2人(含工具)
Ladder assembly: maximum safety load 400kg, suitable for 2 persons
- 2) 模块组件: 最大安全载荷50kg/pc, 高度3650mm
Rail segment: maximum safety load 50kg/pc, height 3650mm
- 3) 带刹脚轮: 最大动态安全载荷800kg, 高度200mm
Brake casters: maximum dynamic safety load 800kg with diameter 200mm

平面尺寸图



- 安全措施:**
Safety Precautions:
- 特别注意在脚轮锁定后, 才能使用走梯组件
It is important not to use construction ladder until the wheels are locked
- 每个工作层一次只能供一人使用
Each working floor may only be used by one person at the time
- 不允许改变结构, 否则不承担任何未来使用结构的责任
It is not permitted to change the construction, the supplier accepts no responsibility for any future use of the structure



